

TAINET

Xstream 1300 Series

MSDSL Termination Unit

USER'S MANUAL



The Professional Partner

TAINET COMMUNICATION SYSTEM CORP.

Headquarters:

No. 25, Alley 15, Lane 120, Sec. 1. Nei-Hu Rd.,
Taipei 114, Taiwan, R.O.C.
TEL: 886-2-26583000
FAX: 886-2-26583232

Beijing Branch:

5F-A, NO.1 Building , 3rd Street , ShangDi information
industry Base , HaiDian District , Beijing , China
Mail BOX:P.O.BOX 100085 EXT.52, Beijing, China
TEL: 86-10-62964775~4779
FAX: 86-10-62964780

FCC NOTICE

This equipment has been tested to comply with limits for a Class A digital device, pursuant to Part 15 of the FCC Rules. These limits are designed to provide reasonable protection against harmful interference when the equipment is operated in a commercial environment. This equipment generates, uses, and can radiate radio frequency energy and, if not installed and used in accordance with instruction manual, may cause harmful interference to radio communication.

If the equipment does cause harmful interference to radio or television devices, the user is encouraged to try to correct the interference by one or more of the following advises:

- *Reorient or relocate the receiving antenna.*
- *Increase the separation between the equipment and receiver.*
- *Connect the equipment into an outlet on a circuit different from that to which the receiver is connected.*
- *Consult the dealer or an experienced radio/TV technician for help.*

The FCC Rule is available from the U.S. government Printing Office, Washington, DC 20402, Stock NO. 004-00000345-4.

The shielded RS-232 cable is to be used in order to ensure compliance with FCC Part 15, and it is the responsibility of the user to provide and use shielded RS-232 cable from NTU to personal computer.

We will not commit to repair this unconditional fault resulting from the user. The warranty issue will only protect for right operations mentioned in the manual, and extra charge for this fault might be noticed if necessary.

Caution *Any changes or modifications not expressly approved by the grantee of this device could void the user's authority to operate the equipment.*

**Copyright ©1999 Tainet Communication System Corporation.
All right reserved
Printed in Taiwan R.O.C.**

Notice

This document is protected by the international copyright law. No part of this publication may be reproduced by any means without the permission of Tainet Communication System Corporation.

TAINET is a registered trademark.

Other product names mentioned in this manual are used for identification purposes only and may be trademarks or trademarks of their respective companies.

The information provided from Tainet Communication System Corporation is believed to be accurate. Any changes and enhancements to the product and to the information thereof will be documented and issued as a new release to this manual.

Trademark

All products and services mentioned herein are the trademarks, service marks, registered trademarks or registered service marks of their respective owners.

ABOUT THIS MANUAL

This section guides you on how to use the manual effectively. The manual contains information needed to install, configure, and operate Tainet's XSTREAM 1300 termination units and also include the symbols used in the manual. The summary of manual is as follows:

Chapter 1 : INSIDE THE XSTREAM 1300

Describes the features, specifications and applications.

Chapter 2 : INTERFACING

Introduces all the interfaces, including front panel and rear panel.

Chapter 3 : INSTALLATION GUIDE

Step-by-step guide to assist user to install and verify the XSTREAM 1300.

Chapter 4 : SYSTEM MENU OPERATION

Gives a description of the system menu items.

Chapter 5 : SYSTEM TERMINAL OPERATION

Gives a description of the system terminal items.

Chapter 6 : ROUTER MODULE OPERATION

Gives a description of the router module items.

Appendix-A : DTE Module Setting

Describes that how to configure using DTE module.

Appendix-B : Order Information

Describes all the XSTREAM 1300 series products.

Appendix-C : Pin Assignment

Describes all cables and connectors with pin definition.

Appendix-D : Loop back

Illustrates the local loop back and digital loop back

Appendix-E : Factory Profiles

Describes all the registers in factory profiles

Appendix-F : Software Upgrade

Guides user to perform the software upgrade function

Appendix-G : Trouble Report

Trouble report form.

GLOSSARY

WARRANTY AND SERVICE

Contact *If there are any questions, contact your local sales representative, service representative, or distributor directly for any help needed. You might use one of the following methods.*

Via the Internet: visit our World Wide Web site at <http://www.tainet.net>

Via the Sales Representatives:

HQ

No. 25, Alley 15, Lane 120, Sec. 1 Nei-Hu Rd., Taipei, Taiwan, R.O.C.

TEL: (886) 2-2658-3000 E-mail: #sales@tainet.net

FAX: (886) 2-2658-3232 URL: <http://www.tainet.net>

Moscow Branch

111024, Shosse Entuziastov, Building 14, Room 425, Moscow, Russia

TEL: (7) 095-7850-377 URL: <http://www.tainet.ru>

FAX: (7) 095-7850-378

Beijing Branch

5F-A, NO.1 Building , 3rd Street , ShangDi information industry Base , HaiDian District , Beijng , China

Tel: 86-10-62964775~4779 E-mail: marketing@tainet.com.cn

Fax: 86-10-62964780 URL: <http://www.tainet.com.cn>

Guangzhou Representative Office

TEL: (86) 20-8758-5976, 8759-0695 FAX: (86) 20-8758-5976

Shanghai Representative Office

TEL: (86) 21-6487-6066, 6427-0809 FAX: (86) 21-6487-5825

Chengdu Representative Office

TEL: (86) 28-522-4651, 522-4652 FAX: (86) 28-522-4652

TABLE OF CONTENTS

CHAPTER 1 INSIDE THE XSTREAM 1300

1.1	Description.....	1-2
1.2	Features	1-3
1.3	Specifications	1-4
1.4	Applications	1-7
1.4.1	Cellular network.....	1-7
1.4.2	Campus network.....	1-8
1.4.3	E1 network	1-9

CHAPTER 2 INTERFACING

2.1	Front Panel.....	2-2
2.1.1	LCD Display.....	2-3
2.1.2	Top Menu	2-3
2.1.3	Status Indicators	2-4
2.1.4	Keypad	2-5
2.2	Rear panel.....	2-7

CHAPTER 3 INSTALLATION GUIDE

3.1	Unpacking	3-2
3.2	Preliminary Preparations.....	3-3
3.3	Set up Procedures.....	3-3
3.4	Configuration Procedures.....	3-4
3.4.1	Load Factory Profile.....	3-4
3.4.2	Local Loop back Test.....	3-5
3.4.3	Make Connection.....	3-6
3.5	Trouble Report.....	3-7

TABLE OF CONTENTS

CHAPTER 4 SYSTEM MENU OPERATION

4.1	Main Menu.....	4-2
4.1.1	Submenu Tree.....	4-4
4.1.2	The Configuration of the XSTREAM 1300.....	4-4
4.1.3	MODEM CONFIG submenu tree	4-5
4.1.4	DTE CONFIG submenu tree.....	4-7
4.1.5	TEST CONFIG submenu tree.....	4-11
4.1.6	STATUS submenu tree	4-12
4.1.7	PROFILE submenu tree	4-14

CHAPTER 5 SYSTEM TERMINAL OPERATION

5.1	Overview	5-2
5.2	Connection.....	5-2
5.3	Keyboard.....	5-2
5.4	Pop-Up Boxes	5-3
5.5	Procedures	5-3
5.6	SYSTEM CONFIGURATION submenu.....	5-5
5.7	DISPLAY STATUS submenu.....	5-6
5.8	LOAD PROFILE submenu.....	5-7

CHAPTER 6 ROUTER MODULE OPERATION

6.1	Description.....	6-2
6.2	LCD Menu Tree	6-3
6.3	The Description of the Configuration.....	6-4
6.3.1	LAN Setup.....	6-4
6.3.2	WAN Setup.....	6-4
6.3.3	PPP Setup	6-4
6.3.4	FrRelay Setup	6-5
6.3.5	AUX Setup	6-5
6.3.6	Routing Table	6-5

TABLE OF CONTENTS

6.3.7	Device Control.....	6-6
6.3.8	Monitor.....	6-6
6.4	How to Operate and Setup Internet Applications.....	6-7
6.5	How to Operate and Setup Intranet Applications.....	6-9

APPENDIX

Appendix-A	DTE Module Setting.....	A-2
Appendix-B	Order Information.....	A-3
Appendix-C	PINS ASSIGNMENT.....	A-5
C-1	V.35 Interface.....	A-5
C-2	RS-530 Interface.....	A-6
C-3	V.36/RS-449 Interface.....	A-7
C-4	X.21 Interface.....	A-8
C-5	DB-9 Interface.....	A-8
C-6	RJ-45 Interface.....	A-9
Appendix-D	Loopback.....	A-10
D-1	Local Loop back.....	A-10
D-2	Digital Loop back.....	A-10
Appendix-E	Factory Profiles.....	A-11
Appendix-F	Software Upgrade.....	A-13
F-1	Overview.....	A-13
F-2	Craft Port Download.....	A-13
F-3	Procedures.....	A-13
F-4	FLASH Download.....	A-14
Appendix-G	Trouble Report.....	A-15

GLOSSARY

LIST OF FIGURES

Figure 1-1 : Cellular network application of the XSTREAM 1300 with G.703 I/F ...	1-7
Figure 1-2 : Campus network application of the XSTREAM 1300 with G.703 I/F ...	1-8
Figure 1-3 : Campus network application of the XSTREAM 1300 with V.35 I/F	1-8
Figure 1-4 : E1 application of the XSTREAM 1300 with G.703 I/F.....	1-9
Figure 2-1 : Front panel of the XSTREAM 1300	2-2
Figure 2-2: The LCD Display.....	2-3
Figure 2-3 : Top Menu of the XSTREAM 1300	2-3
Figure 2-4 : Keypad of the XSTREAM 1300	2-5
Figure 2-5 : The rear panel of the XSTREAM 1300.....	2-7
Figure 2-6 : Terminal block for G.703 E1 balanced interface	2-8
Figure 2-7 : BNC for G.703 unbalanced interface.....	2-8
Figure 2-8 : DB-25 for V.35 and RS-530 interface	2-8
Figure 2-9: Router Module.....	2-8
Figure 3-1 : Network structure.....	3-3
Figure 4-1 : System Menu.....	4-3
Figure 5-1 : The Craft Port Connection to PCs or Terminals COM Port.....	5-3
Figure 5-2 : The main menu of the craft	5-4
Figure 5-3 : Pop-Up Menu of the SYSTEM CONFIGURATION.....	5-5
Figure 5-4 : Pop-Up Menu of the DISPLAY STATUS	5-6
Figure 5-5 : Pop-Up Menu of the Load Profile.....	5-7
Figure 6-1 : Illustration of Router Module.....	6-2
Figure 6-2 : LCD Menu Tree	6-3
Figure 6-3 : The Internet Connection over PPP.....	6-7
Figure C-1 : DB-25M Interface.....	A-5
Figure C-2 : V.35 Interface.....	A-5
Figure C-3 : RS-530 Interface.....	A-6
Figure C-4 : DB-25M Interface.....	A-7
Figure C-5 : DB-37F Interface.....	A-7
Figure C-6 : DB-25M Interface.....	A-8
Figure C-7 : DB-37F Interface.....	A-8
Figure C-8 : RJ-45 Interface.....	A-9
Figure C-9 : RJ-45 Interface.....	A-9
Figure D-1 : Local loop back	A-10
Figure D-2 : Digital loop back	A-10
Figure F-1 : The XSTREAM 1300 Memory Dumps	A-14

LIST OF TABLES

Table 1-1 : Specifications of the XSTREAM 1300.....	1-4
Table 2-1 : Indicators on front panel.....	2-5
Table 2-2 : Definition of key on keypad of the XSTREAM 1300.....	2-6
Table 4-1 : Definition of key on keypad of the XSTREAM 1300.....	4-2
Table 4-2: The MODEM CONFIG submenu items	4-5
Table 4-3 : The DTE CONFIG submenu items.....	4-7
Table 4-4 : The TEST CONFIG submenu items	4-11
Table 4-5 : The STATUS submenu items	4-12
Table 4-6 : The PROFILE submenu items	4-14
Table B-1 : V.35 Cable pin definition.....	A-5
Table C-2 : RS-530 Connector pin definition.....	A-6
Table C-3 : V.36/RS-449 Cable pin definition.....	A-7
Table C-4 : X.21 Cable pin definition.....	A-8
Table C-5 : DB9 Connector pin definition.....	A-8
Table C-6 : DSL RJ-45 Connector pin definition.....	A-9
Table C-7 : LAN RJ-45 Connector pin definition.....	A-9
Table C-8 : AUX port, RJ-45 Connector pin definition.....	A-9
Table E-1 : Profile Setting List 1 (RS-530/V.35)	A-11
Table E-2 : Profile Setting List 2 (G.703 Full E1).....	A-12

CHAPTER 1

INSIDE THE XSTREAM 1300

Overview

- 1.1 Description
- 1.2 Features
- 1.3 Specifications
- 1.4 Applications
 - 1.4.1 Cellular network
 - 1.4.2 Campus network
 - 1.4.3 E1 network

1.1 Description

Tainet's XSTREAM 1300 family uses MSDSL (*Multi-rate Symmetrical Digital Subscriber Loop*) technology to offer the "last mile" transport of repeater less T1/E1 and Nx64 Kbps circuit between customer facilities and central site equipment. The XSTREAM 1300 offers all service providers enormous opportunities to utilize the existing copper infrastructure more efficiently, and it can offer a low cost service with simple installation processes to a substantial part of its subscribers.

Over only a single pair of copper wire, the XSTREAM 1300 family can provide faster speed and longer reach solutions while deploying Nx64 KBPS applications. Those advantages are using the field-proven CAP (*Carrierless Amplitude and Phase Modulation*) modulation technology. Advanced noise immunity and longer loop distance capability will reduce the cost and effort required for repeater installation, compared to traditional T1/E1 or fractional T1/E1 services.

To provide maximum distance, the XSTREAM 1300 can automatically select the available line rate by selection or detection on the DTE speed. The available line rates are 144K, 272K, 400K, 528K, 784K, 1040K, (Xstream1310/1330), 1560K, 2064K and 2320K (Xstream1300/1320) bps. The distance depends on the transmission rate. The higher the line-rate, the shorter the transmission distance will be.

As to the DTE interface, the XSTREAM 1300 can be equipped with an E1 G.703/G.704, V.35, or RS-530 interface and a spare module socket for optional function extension. For example, the G.703 module can be installed as an additional interface for voice application, while the DTE interface can be deployed as the data service.

Furthermore, the Router module (10BaseT interface) is also an optional function extension that can be applied in utilizing the XSTREAM 1300 series for inter-networking connection.



Only one of two interfaces is operational simultaneously via software selection.

The XSTREAM 1300 not only offers reliable service but also provides a well-developed network management system. An embedded SNMP agent for XSTREAM 1300 fitted to the Super Shelf at the central office will provide efficient management capability.

1.2 Features

- ✓ Provides additional transmission distance up to 20 percent longer than competing DSL technologies
- ✓ Carrying symmetrical 2048 Kbps payload for up to 3.2 miles/5.18Km over 24 AWG single pair copper wire
- ✓ Multi Line-Rate support including 144K, 272K, 400K, 528K, 784K, 1040K for Xstream 1310/1330
- ✓ Multi Line-Rate support including 144K, 272K, 400K, 528K, 784K, 1040K, 1552K, 2064K, and 2320K for Xstream 1300/1320
- ✓ Automatic line rate selection according to DTE speed (Nx64Kbps)
- ✓ Easy software upgrade in the field via flash download
- ✓ Flexible management through Craft Port and Front Panel.
- ✓ Automatic output power adaptation according to loop conditions
- ✓ EOC function enables remote configuration and monitoring
- ✓ Support of wetting current to obtain best loop conditions

1.3 Specifications

Table 1-1 : Specifications of the XSTREAM 1300

DSL	
Modulation	128-CAP
Mode	Full duplex with echo cancellation
Number of loops	Single
Loop rate	144 Kbit/S to 2320 Kbit/S
Data rate	64K to 2304Kbit/S (Xstream 1310/1330 up to 1040Kbps)
Loop impedance	135 ohms
Reach (24 AWG, no noise)	128 Kbps : 32,000 feet / 9,750 meters 256 Kbps : 30,000 feet / 9,140 meters 384 Kbps : 28,000 feet / 8,530 meters 512 Kbps : 27,000 feet / 8,230 meters 768 Kbps : 23,000 feet / 7,000 meters 1024 Kbps : 20,000 feet / 6,100 meters 1536 Kbps : 18,000 feet / 5,490 meters 2048 Kbps : 17,000 feet / 5,180 meters 2304 Kbps : 16,000 feet / 4,880 meters
Clock source	CO site - Internal clock/DTE clock CPE site - Receive clock
Clock accuracy	± 32 ppm
DTE Interface	
Module	DTE 1
	G.703 E1 balance interface G.703 E1 unbalance interface Router interface
	DTE 2
	V.35 Nx64 KBPS interface RS-530 Nx64 KBPS interface V.36 Nx64 KBPS interface X.21 Nx64 KBPS interface

Diagnostics	
Interface	LCD, Keypad, Status Indicators, Craft port
Loop test	Local loop back Digital loop back E1 loop back
LCD	2 by 16 characters
Keypad	UP, DOWN, LEFT, RIGHT, HOME & LOC/REM
Status Indicators	PWR : Power indicator CPE : CO/CPE indicator DSL : DSL status indicator DTE1 : DTE1 interface existing indicator DTE2 : DTE2 interface existing indicator SQ : Signal quality indicator ALM : Disconnection indicator TST : Test status indicator
Craft port	2400, 19200, 38400 BPS 8 bit data length None parity 1 stop bit 9-pin/D-sub/female connector
Power Source	
Input	110/220 Vac \pm 10 % 36 ~ 72 Vdc
Power Consumption	< 10 W
Sealing Current	< 5 mA
Environments	
Temperature	0 °C to 50 °C (operating) -40 °C to 70 °C (storage)
Humidity	10% to 80% relative humidity range (operating) non-condensing 5% to 90% relative humidity range (storage)

- This specification is defined under software version V1.04 or later.
(January, 2000)

1.4 Applications

1.4.1 Cellular network

The cellular network user will need to lease larger numbers of E1 circuits in order to connect remote cell sites to mobile telephone switching offices (MTSOs). Tainet's XSTREAM 1300 provides an alternative to standard repeater E1 service. Figure 1-1 shows a cellular network application.

Figure 1-1 : Cellular network application of the XSTREAM 1300 with G.703 I/F

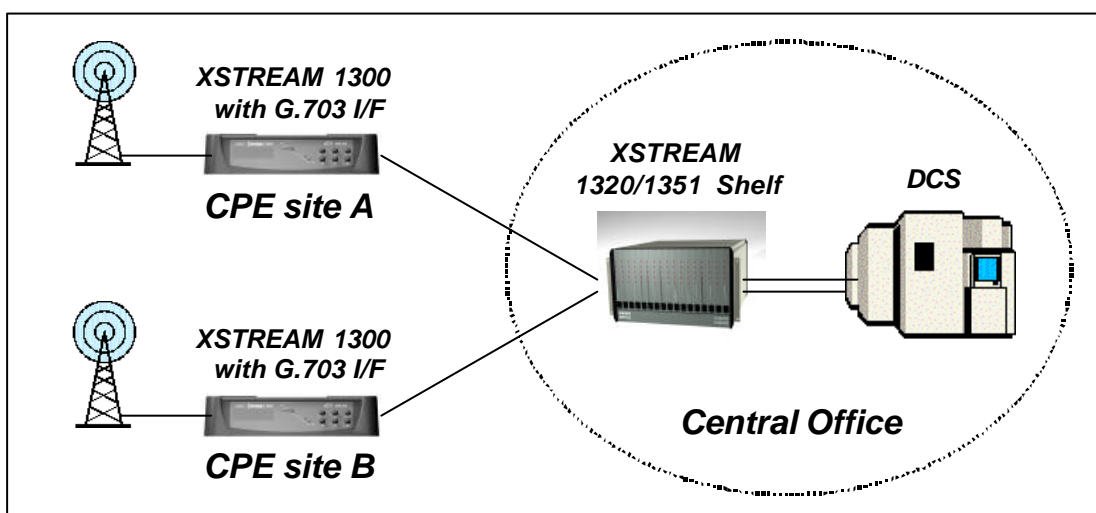

1.4.2 Campus network

The XSTREAM 1300 is well suited to the campus applications. Figure 1-2 and Figure 1-3 show two general campus applications where remote PBX or routers are interconnected across a campus using two XSTREAM 1300. One unit is configured as a central site unit (CO) and the other is the customer premise equipment (CPE) unit.

Each XSTREAM 1300 is configured at the factory to operate at the CO side of an E1 connection. However, you can easily modify CO setting for CPE site unit.

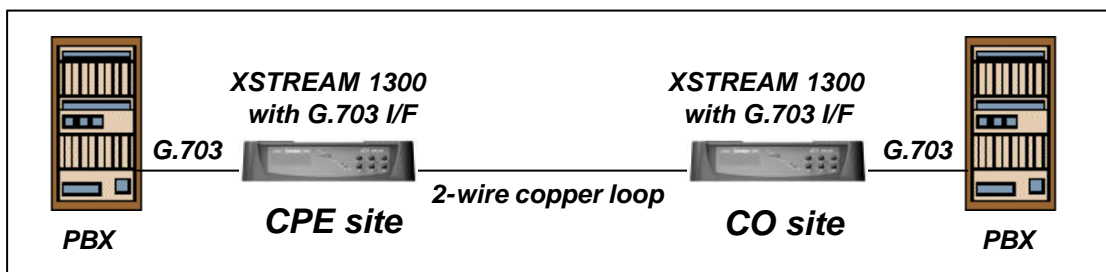

Figure 1-2 : Campus network application of the XSTREAM 1300 with G.703 I/F

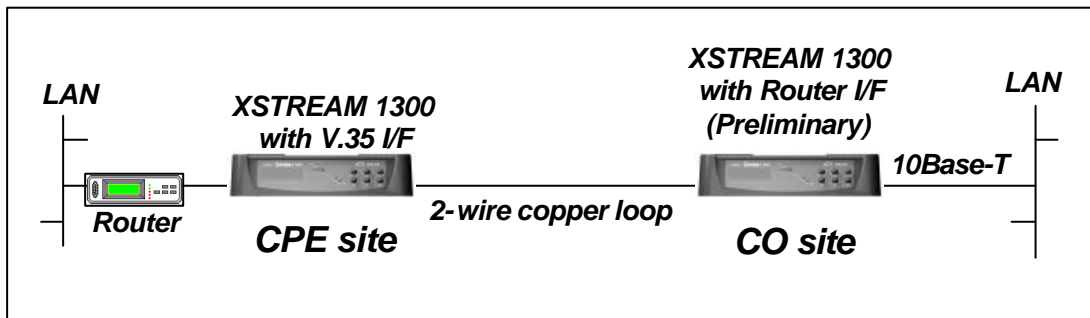

Figure 1-3 : Campus network application of the XSTREAM 1300 with V.35 I/F

1.4.3 E1 network

The XSTREAM 1300 can be deployed to replace tradition E1 network, without the repeater in the E1 network and effectively doubling the utilization of the existing twisted copper pair. Figure 1-4 shows a general E1 network.

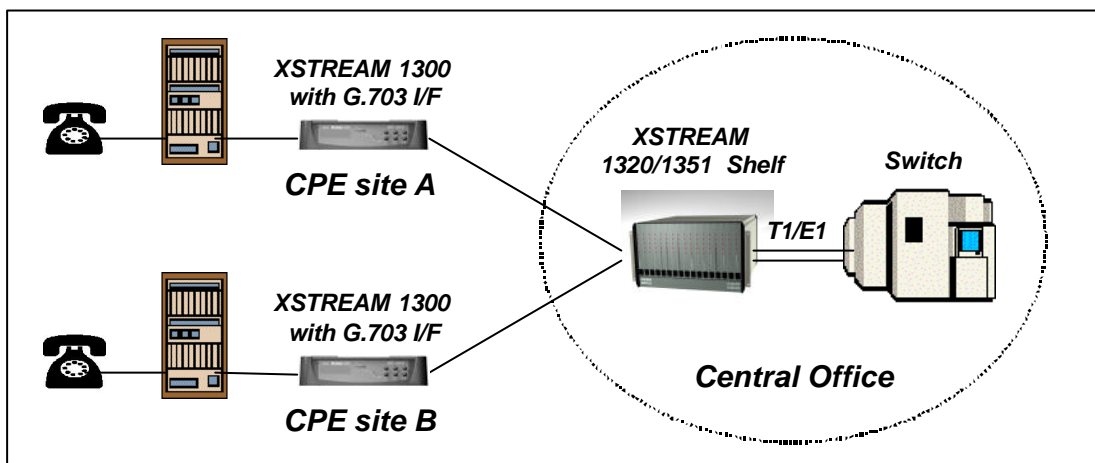

Figure 1-4 : E1 application of the XSTREAM 1300 with G.703 I/F

CHAPTER 2

INTERFACING

Overview

- 2.1 Front Panel
 - 2.1.1 LCD Display
 - 2.1.2 Top Menu
 - 2.1.3 Status Indicators
 - 2.1.4 Keypad
- 2.2 Rear panel

2.1 Front Panel

The front panel of the XSTREAM 1300 is illustrated in Figure 2-1.

There are 3 sections included.

- LCD display
- Status indicators
- Keypad

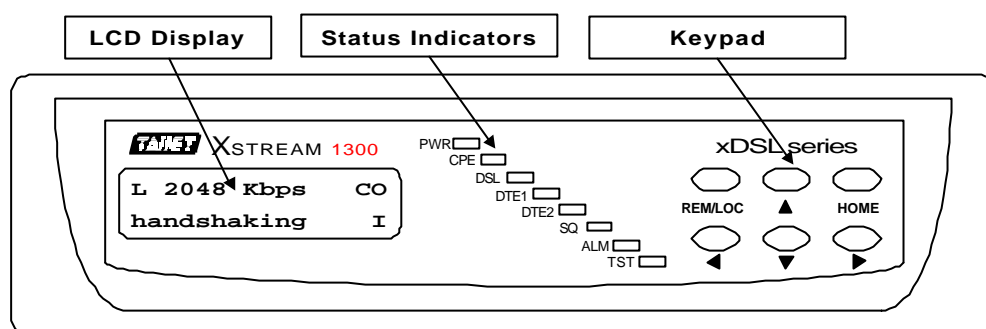

Figure 2-1 : Front panel of the XSTREAM 1300

User can operate the XSTREAM 1300 from the front panel. The following functions can be performed:

- Indicating system signal.
- Displaying system status.
- Setting DTE parameters.
- Configure connection conditions.
- Enabling DSL connection.
- Monitoring loop status.
- Doing system diagnostic
- Enable remote configuration.
- Saving configuration parameters.

2.1.1 LCD Display

The LCD display of the XSTREAM 1300 is a 2 by 16 character screen. The XSTREAM 1300 uses it and keypad to perform all system operations. Figure 2-2 shows the LCD display.

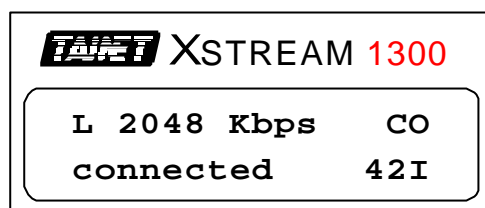

Figure 2-2: The LCD Display

2.1.2 Top Menu

When the XSTREAM 1300 has finished the initialization. The LCD display stays at top menu. Figure 2-3 shows the top menu and is described as follows:

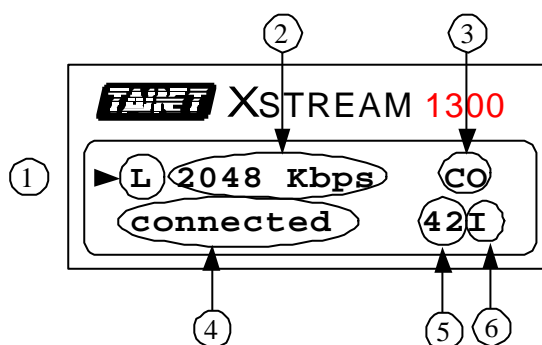

Figure 2-3 : Top Menu of the XSTREAM 1300

1. **L** : Local/Remote. Local or Remote operating indication. **L** represents operating in local, and **R** represents operating in remote.
2. **2048 KBPS** : Speed indication. The item indicates the speed setting if the system is not in DATA mode. Otherwise, it indicates connection speed.
3. **CO** : System operation indication. **CO** indicates that the system is set up to CO mode, **CPE** is CPE mode.
4. **connected** : Operating status indication. Those status include :
 - idle** : *Idle status*
 - handshaking** : *Handshaking*
 - training** : *In training*
 - linked** : *The DSL link has been created*
 - sync hunting** : *Synchronous word is hunting*
 - connected** : *In data mode*
 - local loopb** : *In local loop-back test mode*
 - digital loopb** : *In digital loop-back test mode*
 - disconnect** : *Disconnecting*
5. **42** : S/N value in connecting.
6. **I** : Clock source indication. **I** represent internal clock, **D** represents DTE clock, **R** is receiver clock.

2.1.3 Status Indicators

The status indicators of the XSTREAM 1300 are composed of eight LEDs, **PWR**, **CPE**, **DSL**, **DTE1**, **DTE2**, **SQ**, **ALM** and **IST**. These eight LEDs display the system status. Table 2-1 describes the functions of the status indicators of the XSTREAM 1300.

Table 2-1 : Indicators on front panel

Name	Description	Color	Off	Flashing 0,5 secs	Flashing 0,2 secs	Always On
PWR	POWER	Green	No Power	N/A	N/A	Power OK
CPE	CO/CPE	Green	CO	N/A	N/A	CPE
DSL	Loop	Green	Idle	Handshaking / Training	Linked / Sync hunting	Connecting
DTE1	DTE Port 1	Green	Unequipped or Failure	N/A	N/A	DTE Port 1 Exist
DTE2	DTE Port 2	Green	Unequipped or Failure	N/A	N/A	DTE Port 2 Exist
SQ	Signal Quality	Red	No Error	CRC Error Occurring	N/A	Loop Open
ALM	Alarm/ Event	Red	N/A	N/A	N/A	Disconnection
TST	Testing	Yellow	Normal	Bypass DTE Port 1&2	N/A	LL/DL/E1 Loop back

2.1.4 Keypad

The keypad of the XSTREAM 1300 includes 6 keys, **UP**, **DOWN**, **LEFT**, **RIGHT**, **HOME** and **LOC/REM**. See Figure 2-4. User can perform all system operation via the 6 keys. The key functions are described in Table 2-2.

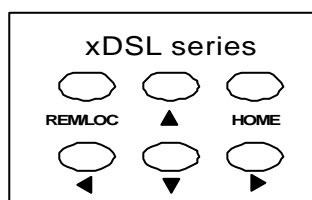





Figure 2-4 : Keypad of the XSTREAM 1300

Table 2-2 : Definition of key on keypad of the XSTREAM 1300

	Go to up layer menu
	Go to down layer menu or decide item
	Move to right menu
	Move to left menu item
HOME	Return to top menu
REM/LOC	Switch menu operation to remote or local



If user selects ‘REM/LOC’ keypad after connection, this will become remote controllable mode while connected. Otherwise, it will still stay at local controlled mode.

2.2 Rear panel

The following connectors are available: AC receptacle, ground terminal, DSL jack, craft interface, DTE1 and DTE2 connectors on the rear panel as shown in Figure 2-5.

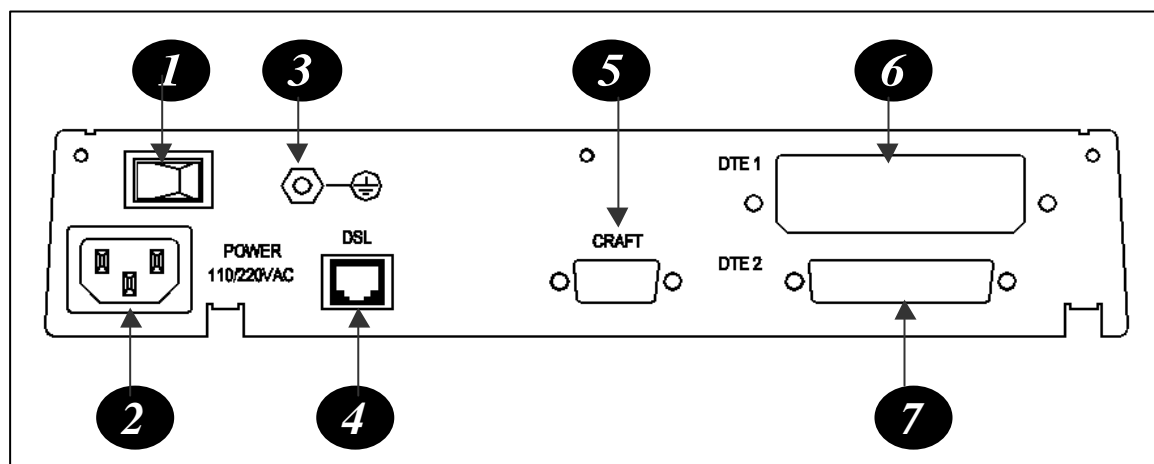

Figure 2-5 : The rear panel of the XSTREAM 1300

1. Power On/Off : The XSTREAM 1300' s power switch
2. AC Receptacle : AC plug for power cord
3. Ground Terminal: Ground output terminal, connect to earth.
4. DSL jack : RJ-45 jack for DSL link
5. Craft Interface : 9 pin female serial D-sub connector
6. DTE1 Interface : Data terminal equipment port 1
7. DTE2 interface : Data terminal equipment port 2

The XSTREAM 1300 supports various DTE (Data terminal equipment) interfaces depending on user requirements. Connector types include ITU-T G.703 E1 balanced interface, G.703 E1 unbalanced interface and DB-25 female connector for V.35, RS-530 and Router module interface, shown in Figure 2-6, 2-7, 2-8 and 2-9.

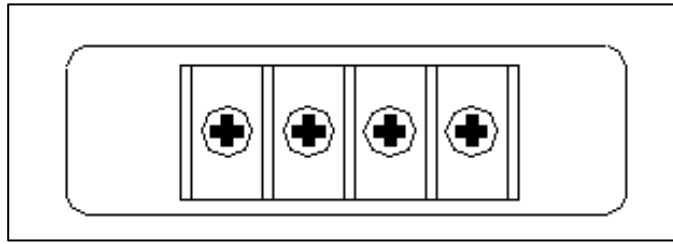

Figure 2-6 : Terminal block for G.703 E1 balanced interface

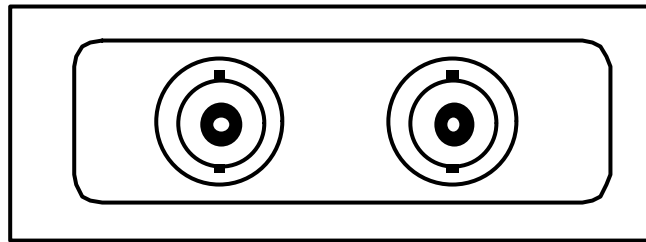

Figure 2-7 : BNC for G.703 unbalanced interface

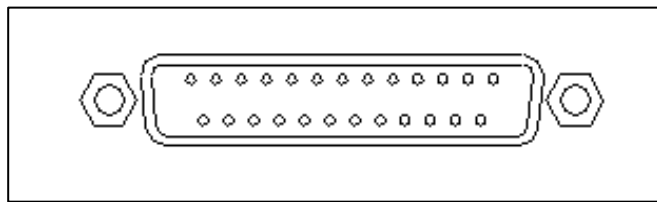

Figure 2-8 : DB-25 for V.35 and RS-530 interface

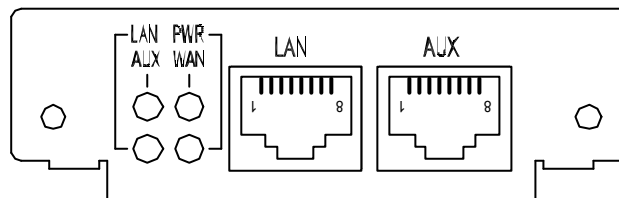
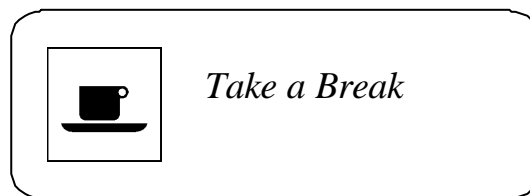

Figure 2-9: Router Module



CHAPTER 3

INSTALLATION GUIDE

Overview

- 3.1 Unpacking
- 3.2 Preliminary Preparations
- 3.3 Set up Procedures
- 3.4 Configuration Procedures
 - 3.4.1 Load Factory Profile
 - 3.4.2 Local Loop back Test
 - 3.4.3 Make Connection
- 3.5 Trouble Report

3.1 Unpacking

The XSTREAM 1300' s shipping package includes the following items:

- A XSTREAM 1300 standalone unit
- The user' s manual
- A power cord
- A 24 AWG RJ-45 cable
- A RJ-45 cable box
- Optional items
 - G.703 E1 Balanced interface
 - ✓ A G.703 E1 Balanced module
 - G.703 E1 Unbalanced interface
 - ✓ A G.703 E1 Unbalanced module
 - ITU-T V.35 Nx64Kbps interface
 - ✓ V.35 module
 - ✓ V.35 cable
 - EIA RS-530 Nx64Kbps interface
 - ✓ RS-530 module
 - 10BaseT interface
 - ✓ Router module

Optional items depend on user applied network interface. The XSTREAM 1300 supports flexible optional interfaces, includes ITU-T G.703 E1 balanced interface, ITU-T G.703 E1 unbalanced interface, ITU-T V.35 Nx64 Kbps interface and EIA RS-530 Nx64 Kbps interface.

3.2 Preliminary Preparations

To test the XSTREAM 1300's functions, you need to have the following equipment and accessories.

- ✓ XSTREAM 1300 terminal unit with DTE module x 2
- ✓ BER tester x 2
- ✓ Power cord x 4
- ✓ RJ-45 twisted cable x 1
- ✓ Test cable x 2

3.3 Set up Procedures

1. Plug power to the XSTREAM 1300
2. Plug power to data terminal equipment
3. Plug power to BER tester.
4. Connect the RJ-45 twisted cable to the RJ-45 jack on rear panel of the two XSTREAM 1300.
5. Connect test cable to the DTE interface of XSTREAM 1300 and the BER tester.

User can also use a terminal emulation program to configure the XSTREAM 1300. Configure terminal for 19200 BPS, eight data bit, no parity, one stop bit, echo off and no flow control. You may need a standard cable terminated with a DB9 male to DB25 female, to connect the serial port of your terminal and the craft port located on the rear panel of the XSTREAM 1300. Figure 3-1 shows the structure of the testing network

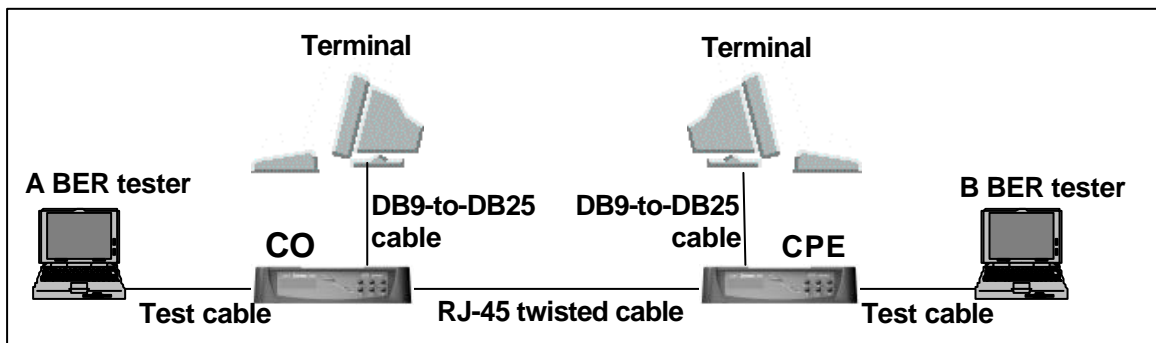

Figure 3-1 : Network structure

3.4 Configuration Procedures

This section guides the user in some basic operations via front panel and to make sure the XSTREAM 1300 unit is correctly configured. The operations include *Load Factory Profile*, *Local Loop back Test* and *Make Connection*.

3.4.1 Load Factory Profile

1. Switch on the XSTREAM 1300 and wait until LCD's screen shows as top indicated.
2. Press **DOWN**, **LEFT**, **DOWN**, **DOWN** keys in sequence as shown below

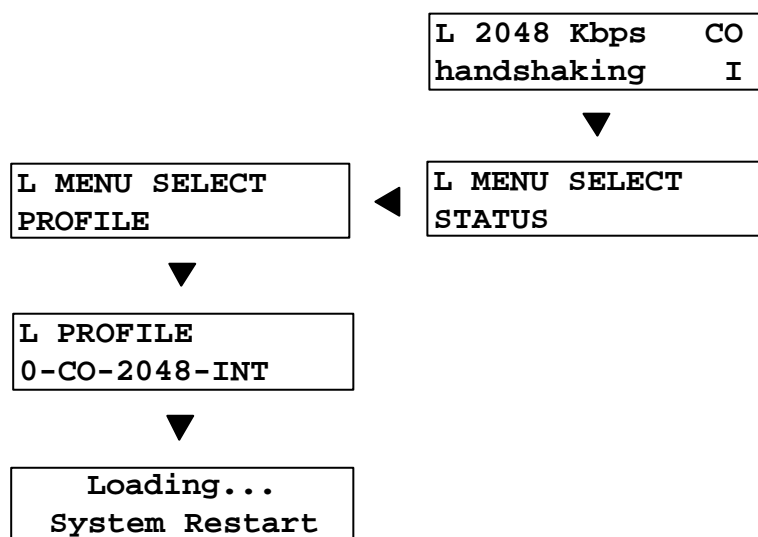

3. When you have finished these procedures, you will find the XSTREAM 1300 performing a soft-start.

3.4.2 Local Loop back Test

1. Turn on the XSTREAM 1300 and wait for LCD' s screen to show as top indicated :
2. Press **DOWN**, **RIGHT** 3 times, **DOWN**, **RIGHT**, **DOWN** key and the LCD' s screen to show :

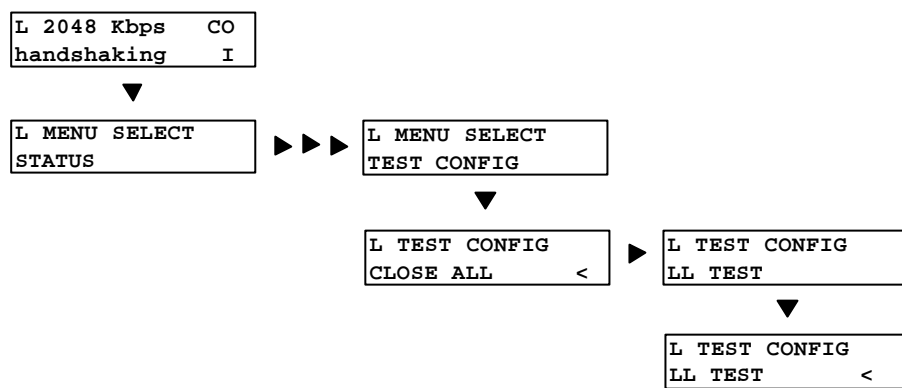

3. Press **HOME** key. Wait for several seconds, the XSTREAM 1300 will perform LL test mode.

```

L 2048 Kbps CO
local loopb I
  
```

3.4.3 Make Connection

1. Repeat section 3.4.1 steps 1 to 3 for CO unit. Press **HOME** key and the LCD shows :

```
L 2048 Kbps   CO
handshaking   I
```

2. Repeat section 3.4.1 steps 1 to 3 for CPE unit, just select the different profile as LCD shows:

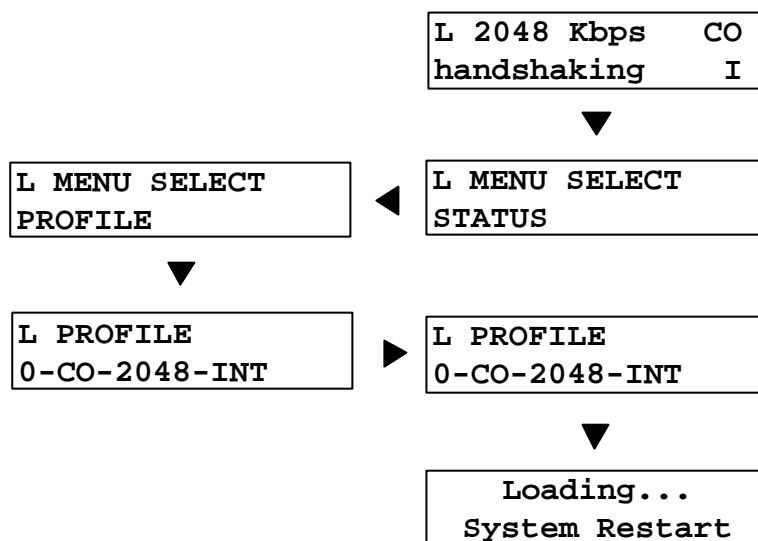

3. Wait for several seconds, both XSTREAM 1300 will perform “CONNECTING” test mode.

```
L 2048 Kbps   CO
connected     42I
```

```
L 2048 Kbps   CPE
connected     42R
```

4. Make sure both BER testers are connected.

3.5 Trouble Report

The LCD screen will show the above display when you have followed above operation procedures. If not, please these steps several times to double check. You can utilize the trouble report (refer Appendix-G Trouble Report). If you still cannot get the right display, you can obtain help via email or fax from your nearest dealer, or directly from Tainet.

CHAPTER 4

SYSTEM MENU OPERATION

Overview

4.1 Main Menu

- 4.1.1 Submenu Tree
- 4.1.2 The Configuration of the XSTREAM 1300
- 4.1.3 MODEM CONFIG submenu tree
- 4.1.4 DTE CONFIG submenu tree
- 4.1.5 TEST CONFIG submenu tree
- 4.1.6 STATUS submenu tree
- 4.1.7 PROFILE submenu tree

4.1 Main Menu

The XSTREAM 1300's menu tree consists of various sub-menus. Users can perform all system operations of the XSTREAM 1300 by using the keypad on front panel and the LCD display.

Table 4-1 : Definition of key on keypad of the XSTREAM 1300





	Go to up layer menu
	Go to down layer menu or decide item
	Move to right menu
	Move to left menu item
HOME	Return to top menu
REM/LOC	Switch menu operation to remote or local

Figure 4-1 shows display screens from switch on until completed.. The menu has been shown for connected (Local and Remote XSTREAM 1300 Devices have been connected) or non-connected. It will constantly return to the top menu while user might press **HOME** key. To go to the sub-menu, user may press **UP**, **DOWN**, **LEFT** and **RIGHT** to select and then go to the next or other layers of the menu tree.



#1 When V.35 or RS-530 Interface Exist
 #2 When E1 Interface Exist
 #3 When Router Module is install, a menu "Router Module" will appear.
 Refer to chapter 6 for detail.

Figure 4-1 : System Menu

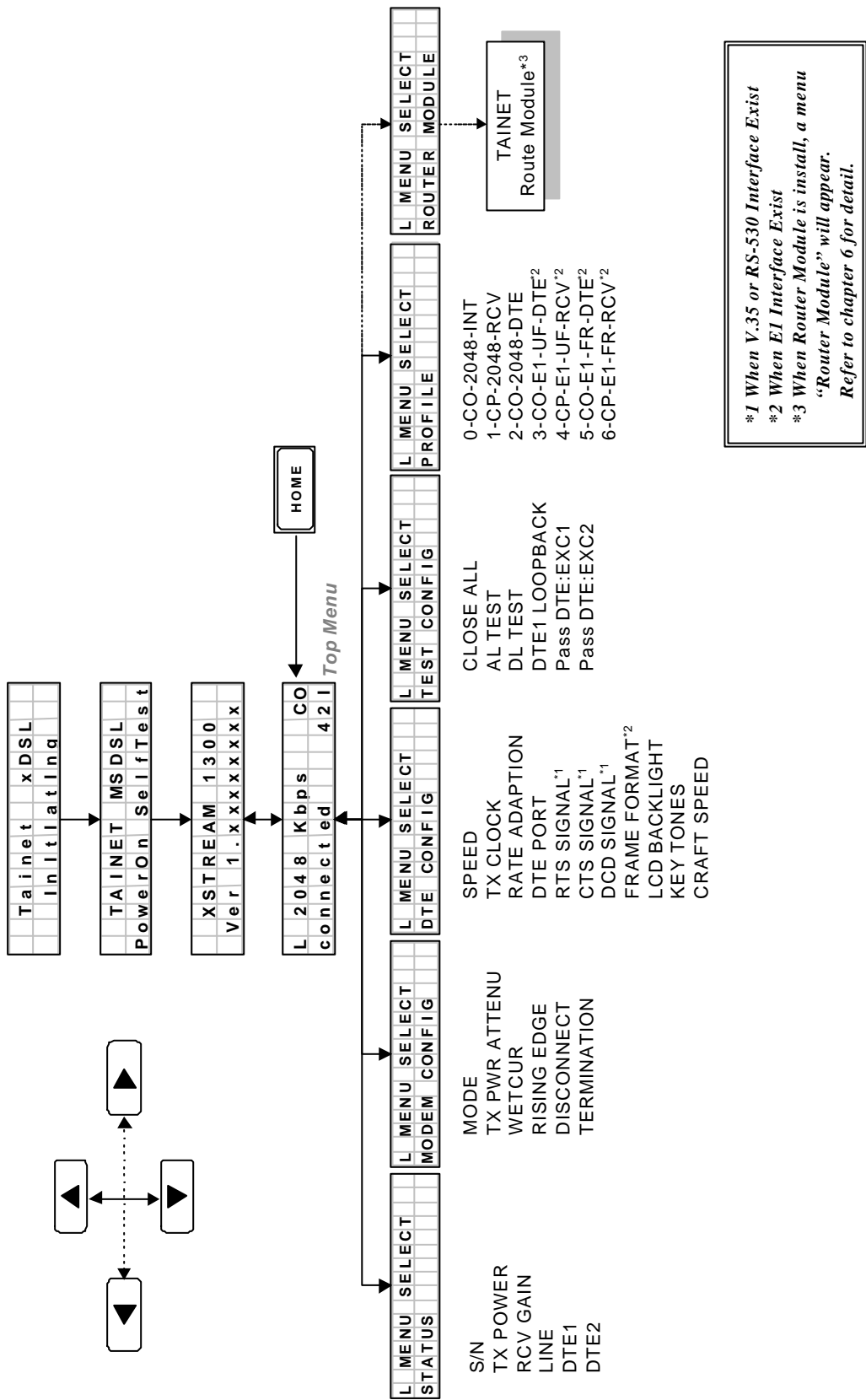
4.1.1 Submenu Tree

The XSTREAM 1300 has five different sub menu trees as following:

- ✓ **STATUS**
- ✓ **MODEM CONFIG**
- ✓ **DTE CONFIG**
- ✓ **TEST CONFIG**
- ✓ **PROFILE**

Each sub-menu contains the individual selectable items. Some of the submenu trees are subject to change with later software versions. User can download the updated software through Tainet's Internet Web site.



Only the registered user is authorized to download the software. Please call the local representative to help in upgrading the

4.1.2 The Configuration of the XSTREAM 1300

The configuration can be modified and saved by the user. The XSTREAM 1300 starts up with its default factory profile. User will find two types of the XSTREAM 1300 configuration as follows.

- ✓ *Current Profile (Default Configuration)*
- ✓ *Factory Profile (Loaded from Factory Configuration)*

When neither of the default settings meet the requirement of the network's configuration, you can select the customized configuration for your application.

The configuration of the XSTREAM 1300 includes three sub-menu trees :

- ✓ **MODEM CONFIG**
- ✓ **DTE CONFIG**
- ✓ **TEST CONFIG**

4.1.3 MODEM CONFIG submenu tree



The parameters should be modified carefully, because some of the procedures may cause the system disconnection.

The XSTREAM 1300 is a standalone terminal unit that can be manually set up by the user. The **MODEM CONFIG** submenu trees offer the basic configuration for network installation purpose.

The operation of the set up procedures requires the basic knowledge of the network field. The easy way is to choose the default setting except when the network does not perform correctly. The sub-menu tree of the **MODEM CONFIG** of the XSTREAM 1300 is shown in the Table 4-2.

Table 4-2: The MODEM CONFIG submenu items

MODEM CONFIG

MODE

Description:

Indicates the placement of the unit in the network configuration. The system will re-connect when user changes this item.

Options:

CO	Central Office site
CPE	Customer Premises Equipment site

TX PWR ATTENU

Description:

Transmission Power Attenuation

Options:

+2 dB to -15dB	Plus the transmission power attenuation
----------------	---

WETCUR

Description:

Wetting Current to Prevent line corrosion. The LINE selection of STATUS [p.29] is unavailable [N/A] when user turns this selection off. The wetting current selection is fully optional.

Options:

ON	Turn on the wetting current
OFF	Turn off the wetting current

RISING EDGE

Description:

DTE Transmit Data Signal Stage

Options:

NORMAL	Framer sets-up automatically
FALLING EDGE	Force DTE transmit data is clocked at falling edge
RISING EDGE	Force DTE transmit data is clocked at rising edge

DISCONNECT

Description:

Disconnection Mode

Options:

AUTOMATIC	Disconnect according to the XSTREAM 1300 automatically
MANUAL	Disconnect if the disconnection button is pressed. Time only is indicated.

TERMINATION

Description:

Terminal Impedance Match

Options:

HI-Z	140 Ω
LOW-Z	135 Ω

4.1.4 DTE CONFIG submenu tree

This submenu tree provides the best solution if the DTE equipment cannot connect properly to the XSTREAM 1300. If users experience problems connecting to the DTE equipment, a good choice is to modify the DTE configuration to meet requirements for both ends. The table of the **DTE CONFIG** submenu can be found in the Table 4-3.

Table 4-3 : The DTE CONFIG submenu items

DTE CONFIG

SPEED

Description:

Set up the Speed of the XSTREAM 1300

Options:

64 KBPS	1 x 64 KBPS
128 KBPS	2 x 64 KBPS
:	:
:	:
1040 KBPS	16 x 64 KBPS
1552 KBPS	24 x 64 KBPS (Xstream 1300/ 1320 only)
2048 KBPS	32 x 64 KBPS (Xstream 1300/ 1320 only)
2304 KBPS	36 x 64 KBPS (Xstream 1300/ 1320 only)

TX CLOCK

Description:

Determine the Transmission Clock Source

Options:

INTERNAL CLOCK	The unit's internal clock is used as the clock source
DTE CLOCK	The DTE interface is used as the clock source
RECEIVE CLOCK	The clock recovers from loop is used as the clock source

RATE ADAPTION

Description:

DTE Clock Auto Baud Rate (CO side only)

Options:

FOLLOW SET-UP	According to software set up
BY DTE CLOCK	Specifically by DTE clock

DTE PORT

Description

Data Port Selection

Options:

DTE 1	Use the data port 1 (DTE1)
DTE 2	Use the data port 2 (DTE2)

RTS SIGNAL [V.35] [RS-530]

Description:

Request to Send

Options:

NORMAL	Detects the DTE interface RTS signal
FORCE ON	Forces the RTS signal continuously on

CTS SIGNAL [V.35] [RS-530]

Description:

Clear to Send

Options:

NORMAL	It is active after connecting
FOLLOW RTS	It is active if the RTS signal is active

DCD SIGNAL [V.35] [RS-530]

Description:

Data Carrier Detector

Options:

NORMAL	It is active after connecting
FORCE ON	Forces the DCD signal continuously on
FOLLOW RMT-RTS	It is active if the remote side of RTS signal is active

DTE2 RxD [V.35F] [RS-530F]

Description:

DTE2 output data signal. When network uses a single clock source, and requires the RxD signal to follow the ExC signal.

Normally the RxD signal follows the RxC signal.

Options:

FOLLOW RxC	Force the RxD signal to follow RxC signal
FOLLOW ExC	Force the RxD signal to follow ExC signal
FOLLOW ExC INV	Inverted. Force the ExC signal to follow RxD signal

FRAME FORMAT [E1]

Description:

Specify the E1 Framing Format

Options:

UNFRAMED	Full E1 payload rate of 2048 Kbps
FRAMED	Framing is enabled
FRAMED+CRC4	Framing is enabled with CRC4

TIME SLOT START [E1]

Description:

Specify the number of the First Time Slot to be used

Options:

1 to 31	Time slot 1 to Time slot 31
---------	-----------------------------

TIME SLOT NO [E1]

Description:

Specify the number of Time Slots to be used

Options:

1 to 31	1 to 31 Time slots
---------	--------------------

Example:

When	FRAME FORMAT	: FRAMED+CRC4
	TIME SLOT STAR	: 5
	TIME SLOT NO	: 4

There are 4 time slots available for data payload (4 x 64 = 256 KBPS) when using time slot 5, 6, 7 and 8, the CRC4 of time slot 0 framing format is enabled.

LCD BACKLIGHT

Description:

Specify turning on period the LCD backlight

Options:

OFF	Always off
ON 3 MIN.	Turn off after last key press 5 minutes later
ALWAYS ON	Always on

KEY TONES

Description:

Turn the key tones on or off

Options:

ON	Turn on the key tones
OFF	Turn off the key tones

CRAFT SPEED

Description:

Specifies the Craft Port Speed (Data length 8 bits - No parity check - 1 stop bit)

Options:

9600, 19200 and 38400 BPS

According to the above tables, users may customize their own configurations to meet network requirements. All of them are editable when the specified item has been selected.

4.1.5 TEST CONFIG submenu tree

When user has doubts about network connection, the XSTREAM 1300 provides a group of loop back functions for the user and offers test loop backs to check the conditions of the device status. The loop back functions include the following:

- ✓ **LL TEST** : *Local Loop back Test*
- ✓ **DL TEST** : *Digital Loop back Test*
- ✓ **DTE1 LOOPBACK** : *DTE1 Loop back Test*

The **TEST CONFIG** submenu tree is shown in the Table 4-4.

Table 4-4 : The TEST CONFIG submenu items

TEST CONFIG

Description:

The XSTREAM 1300' s Test Configuration

Options:

CLOSE ALL	
LL TEST	Local Loop back Test
DL TEST	Digital Loop back Test

E1 LOOP BACK E1 Loop back test [only operates when G703 interface is inserted.]

4.1.6 STATUS submenu tree

Before or after the configuration set up step, user can monitor the device through the **STATUS** option of the menu tree. The table of the **STATUS** submenu can be found in the Table 4-5.

Table 4-5 : The STATUS submenu items

STATUS

S/N

Description:

Signal / Noise Ratio, the unit is dB

TX POWER

Description:

Transmitted Power, the unit is dBm

RCV GAIN

Description:

Receiver Gain, the unit is dB

LINE

Description:

Loop Distance Detection. The item is only available when the XSTREAM 1300 set to CO site and wetting current turn on.

Probabilities:

N/A	Unavailable when turning off the wetting current
LOOP SHORT	The DSL loop maybe be shorted
< 200 M	The estimation distance of DSL loop is smaller than 200 meters
n M	Estimation distance of DSL loop, unit is in meters
LOOP OPEN	The DSL loop is open

DTE1

Description:

DTE1 port interface type

Probabilities:

NOT EQUIPPED	No DTE
E1 G.703B	E1 G.703 balanced interface
E1 G.703UB	E1 G.703 unbalanced interface
Router	Router Module interface
EXIST	DTE interface exist but unknown type

DTE2

Description:

DTE 2 port interface type

Probabilities:

NOT EQUIPPED	No DTE equipped
V.35	V.35 interface
RS-530	RS-530 interface
EXIST	DTE interface exist but unknown type

All of the conditions that the user has tried in the configuration set up, will be monitored and viewed only under the **STATUS** submenu tree. It provides the user with the best tools for checking all the states of the network connection.

4.1.7 PROFILE submenu tree

Use a **PROFILE** from the manufacturer. For quick configuration steps, it may be helpful and will assist the user to maintain the system as well. The sub-menu tree of the **PROFILE** is shown in Table 4-6

Table 4-6 : The PROFILE submenu items

PROFILE

Description:

Configuration Profile Setting

Options:

0-CO-2048-INT	CO Site, 2048 KBPS, internal clock
1-CP-2048-RCV	CPE Site, 2048 KBPS, receiver clock
2-CO-2048-DTE	CO Site, 2048 KBPS, DTE clock
3-CO-E1-UF-DTE	CO Site, E1, DTE clock
4-CP-E1-UF-RCV	CPE Site, E1, receiver clock
5-CO-E1-FR-DTE	CO Site, E1, DTE clock, Frame CRC4
6-CP-E1-FR-RCV	CPE Site, E1, receiver clock, Frame CRC4

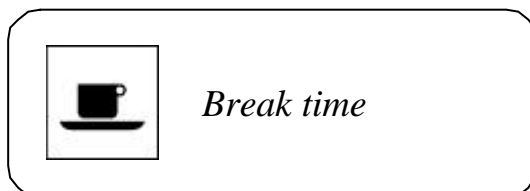

CHAPTER 5

SYSTEM TERMINAL OPERATION

Overview

- 5.1 Overview
- 5.2 Connection
- 5.3 Keyboard
- 5.4 Pop-Up Boxes
- 5.5 Procedures
- 5.6 SYSTEM CONFIGURATION submenu
- 5.7 DISPLAY STATUS submenu
- 5.8 LOAD PROFILE submenu

5.1 Overview

The system terminal may be attached to craft port of the XSTREAM 1300 through the RJ-45 jack on rear panel. The craft port is a terminal device with asynchronous protocol supported. On the other hand, the COM port interface of the PCs or Terminals allows users to connect the 9-pin end of the terminal cable into COM port. The communication parameters are set to speed 9600 BPS, 8 data bits, no parity, and 1 stop bit format. User can use any terminal emulation program to set up the XSTREAM 1300 via craft port.

5.2 Connection

The craft port operation of the XSTREAM 1300 is similar to a normal PC. To view the whole operation, user can utilize a PC monitor instead of the LCD panel.

5.3 Keyboard

The keyboard is used to select and manipulate the basic operation of the XSTREAM 1300 as following:

- ✓ *Arrow Keys (Up, Down, Left, and Right)*
- ✓ *Number Keys (1 ~ 9) to select items*
- ✓ *Enter or Return Key (make the selection of each operation)*
- ✓ *Space Bar (Used to change a highlighted field and bring up next choice)*
- ✓ *Special Function Keys*
 - *Ctrl-R (Refresh the current screen with the original values)*
 - *TAB (Choose Remote or Local System Mode)*
 - *ESC (Quit and out of the operation)*

5.4 Pop-Up Boxes

Once an error or any information note has occurred, a pop-up box will appear over the current screen to assist operations.

The Craft Port could assist the system maintenance for a standalone termination unit like the XSTREAM 1300. The PCs or Terminals with COM port could be connected to the XSTREAM 1300 via the Craft Port.

5.5 Procedures

1. Make sure that PCs or Terminals of the COM port setting are set to
 - ✓ *At least 9600 baud rate*
 - ✓ *8-bit characters*
 - ✓ *No parity*
 - ✓ *1 stop bit*
 - ✓ *Hardware flow control*
 - ✓ *ANSI terminal type*
2. Plug the 9-pin of the terminal cable to both ends (the XSTREAM 1300's Craft Port and PC's COM port). (See Figure 5-1)

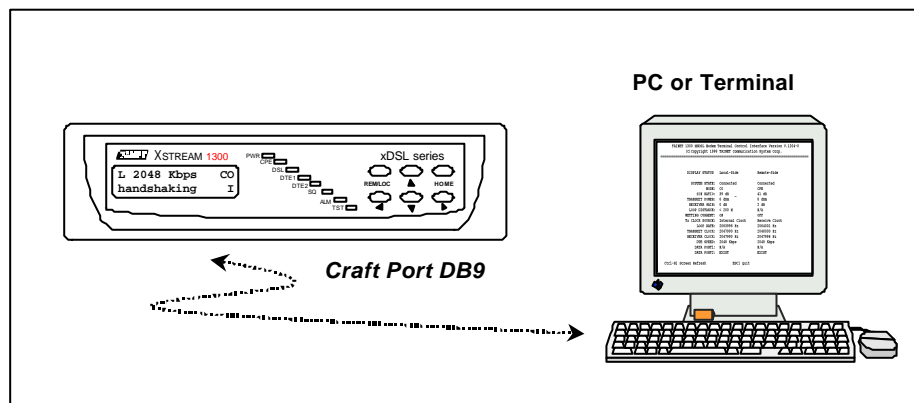

Figure 5-1 : The Craft Port Connection to PCs or Terminals COM Port

3. If the PC' s COM port is not the 9-pin of the terminal cable but 25-pin one, the user can change the adapter through correct pin assignments.
4. The main menu screen will display on the PC' s or Terminal s Monitor if the connection is successful. (See Figure 5-2)
5. If there is no main menu on the screen, press Ctrl-R to refresh screen.

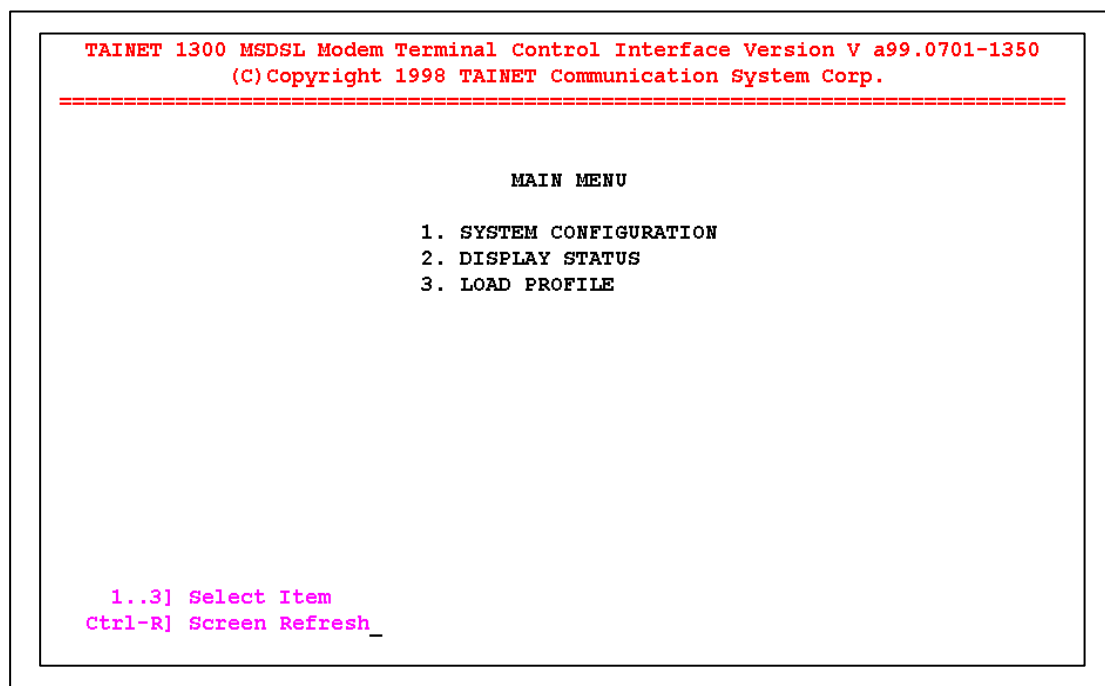

Figure 5-2 : The main menu of the craft

5.6 SYSTEM CONFIGURATION submenu

As mentioned in chapter 3, the configuration is set up via LCD Front Panel. In this section, the configuration is set up via PCs or Terminals. The main menu display on the screen is shown in the Figure 5-2. There are three options to be selected, i.e. **System Configuration**, **Display Status**, and **Load Profile**.

To configure the XSTREAM 1300 device, user selects option one – **SYSTEM CONFIGURATION** and the next pop-up menu will come up as Figure 5-3.

It is clear that the System Configuration has come up with six options to be chosen by the user. The first three options (1 ~ 3), **MODE**, **Tx Pwr ATTENUATION**, and **WETTING CURRENT**, are the same as the submenu tree of the MODEM CONFIG. The last three-option (4 ~ 6), **DTE SPEED**, **TXCLOCK SOURCE**, and **DATA PORT SELECTION**, are the same as the sub-menu tree of the **DTE CONFIG**.

```

TAINET 1300 MSDSL Modem Terminal Control Interface Version V a99.0701-1554
(C)Copyright 1998 TAINET Communication System Corp.
=====

          SYSTEM CONFIGURATION      Local-Side      Remote-Side

1. MODE           : CPE              CO
2. Tx Pwr ATTENUATION : -3 dB         -3 dB
3. WETTING CURRENT : OFF            ON
4. DTE SPEED      : 2048 Kbps        2048 Kbps
5. TX CLOCK SOURCE : Receive Clock    Internal Clock
6. DATA PORT SELECTION : Data Port 2  Data Port 2

1..7] Select Item      TAB] Remote/Local      SPACE] Modify
Ctrl-R] Screen Refresh ESC] Quit              ENTER] Accept

```

Figure 5-3 : Pop-Up Menu of the **SYSTEM CONFIGURATION**

Press **TAB** key can change sides between local and remote when system is in DATA mode.

To modify the system parameters, enough information on the bottom line is provided to help the user to change the settings.

5.7 DISPLAY STATUS submenu

When user does configuration of the XSTREAM 1300, he can monitor the system status and parameters via the **DISPLAY STATUS**. The basic Pop-Up menu can be found in the Figure 5-4.

```
TAINET 1300 MSDSL Modem Terminal Control Interface Version V a99.0701-1554
(C)Copyright 1998 TAINET Communication System Corp.
=====

DISPLAY STATUS   Local-Side           Remote-Side

SYSTEM STATE:   Connected           Connected
MODE:           CPE                 CO
S/N RATIO:      40 dB             41 dB
TRANSMIT POWER: 8 dBm             8 dBm
RECEIVER GAIN:  0 dB             0 dB
LOOP DISTANCE:  N/A             < 200 M
WETTING CURRENT: OFF           ON
Tx CLOCK SOURCE: Receive Clock  Internal Clock
DTE SPEED:      2048 Kbps       2048 Kbps
DATA PORT1:     E1 G.703 UB     E1 G.703 B
DATA PORT2:     V.35            V.35

Ctrl-R] Screen Refresh           ESC] Quit
```

Figure 5-4 : Pop-Up Menu of the **DISPLAY STATUS**

The **DISPLAY STATUS** of the XSTREAM 1300 provides some useful information for monitoring and checking the system. These numbers are monitored values, and cannot be changed by the user.

5.8 LOAD PROFILE submenu

If user has difficulty in configuring the XSTREAM 1300, they can make use of the Load Profile menu.

```
TAINET 1300 MSDSL Modem Terminal Control Interface Version V a99.0701-1350
(C)Copyright 1998 TAINET Communication System Corp.
=====

                                LOAD PROFILE

0. CO - 2048 Kbps - Internal Clock
1. CP - 2048 Kbps - Receive Clock
2. CO - 2048 Kbps - DTE Clock
3. CO - Unframe E1 - DTE Clock
4. CP - Unframe E1 - Receive Clock
5. CO - Frame CRC4 - DTE Clock
6. CP - Frame CRC4 - Receive Clock

0..2] Select Item
Ctrl-R] Screen Refresh      ESC] Quit_
```

Figure 5-5 : Pop-Up Menu of the Load Profile

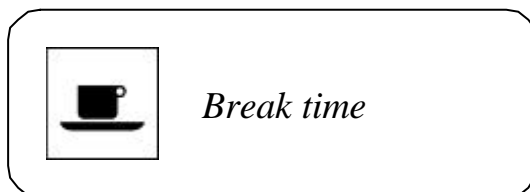

CHAPTER 6

ROUTER MODULE OPERATION

Overview

- 6.1 Description
- 6.2 LCD Menu Tree
- 6.3 The Description of the Configuration
 - 6.3.1 LAN Setup
 - 6.3.2 WAN Setup
 - 6.3.3 PPP Setup
 - 6.3.4 FrRelay Setup
 - 6.3.5 AUX Setup
 - 6.3.6 Routing Table
 - 6.3.7 Device Control
 - 6.3.8 Monitor
- 6.4 How to Operate and Setup Internet Applications
- 6.5 How to Operate and Setup Intranet Applications

6.1 Description

When the Xstream 1300 is installed with a Router Module, an extra function called “Router Module” will appear on the Main Menu.

Following is the illustration of Router Module.

To install the router module onto Xstream 1300, unscrew the cover and firmly install the router module to DTE1 interface as illustrated.

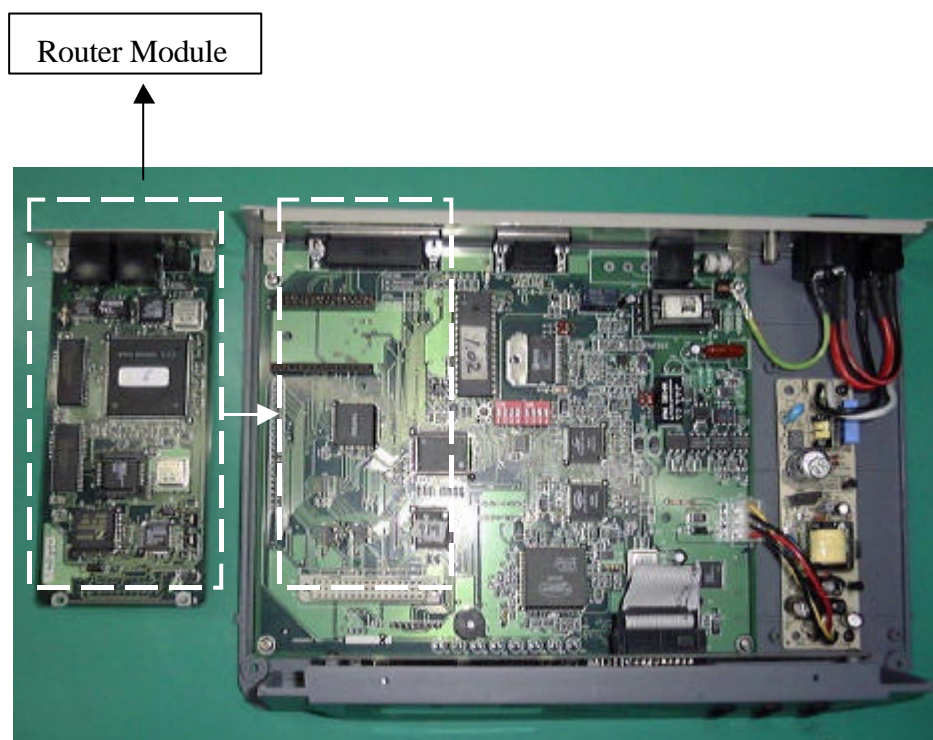

Figure 6-1 : Illustration of Router Module

The function of the router module is described in the next section.

6.2 LCD Menu Tree

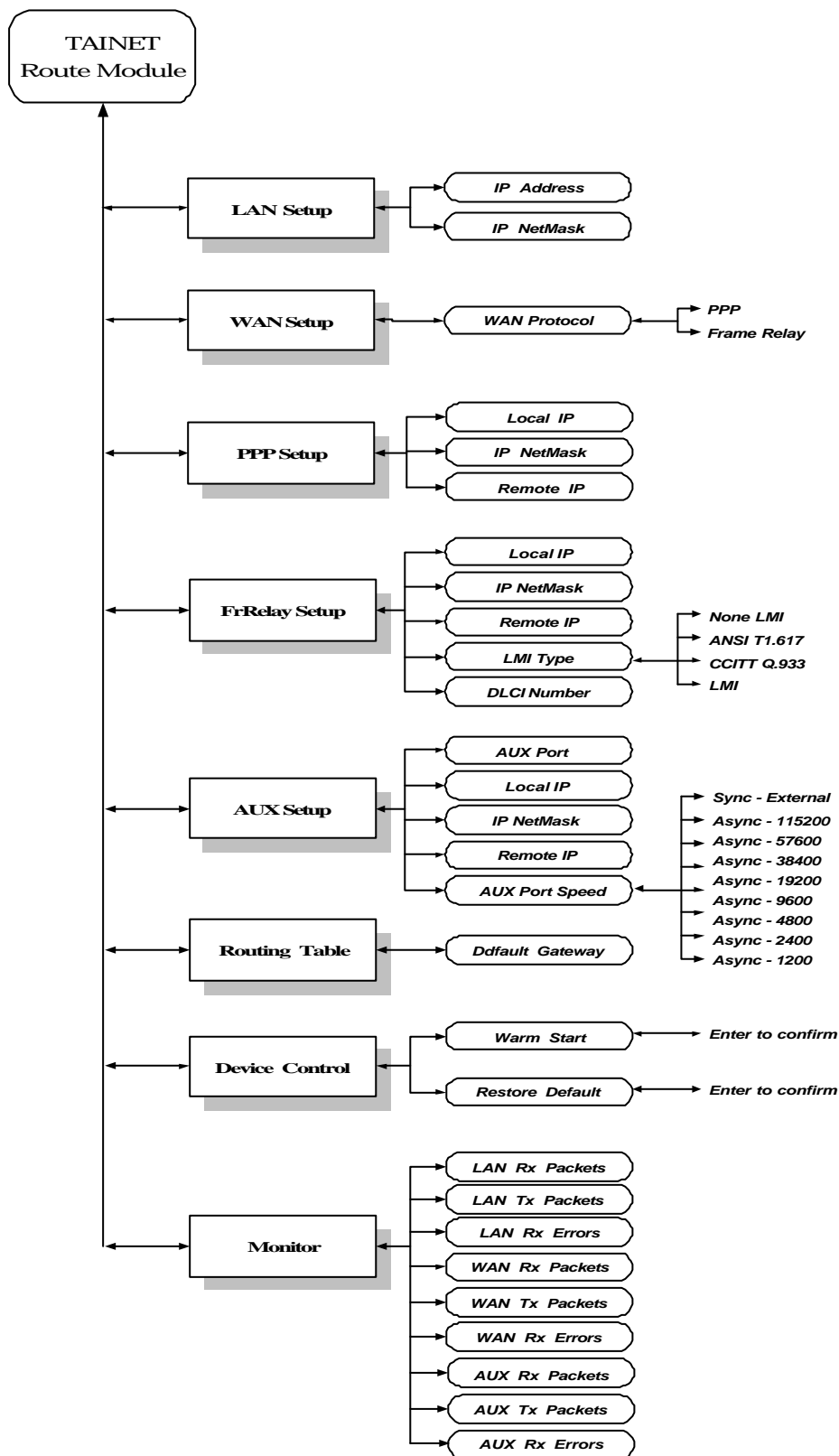

Figure 6-2 : LCD Menu Tree

6.3 The Description of the Configuration

6.3.1 LAN Setup

IP Address	<p>The IP address is a unique 4-byte (32-bit) numeric value used to identify a network and a local host on that network. Each IP address consists of four sets of decimal numbers separated by the period (e.g. 192.72.243.1).</p> <p>Each address is composed of two parts: a network part and a host part. The network part identifies the unique subnet that contains the host; the host part identifies the actual host device.</p>
IP NetMask	<p>The IP address netmask (also 32 bits, written in dotted decimal notation) is used in conjunction with an IP address to specify which bits of the address make up the network part and which the host part. A one (1) in a mask bit location means the corresponding bit in the IP address is part of the network value; a zero (0) means the corresponding bit is part of the host value.</p>

6.3.2 WAN Setup

WAN Protocol	<p>The Xstream 1300's router module supports PPP and Frame Relay. This parameter identifies what protocol WAN port is used.</p>
---------------------	---

6.3.3 PPP Setup

Local IP	<p>This parameter identifies the IP address for local WAN port when the WAN protocol is selected PPP.</p>
IP Netmask	<p>WAN port IP netmask when the WAN protocol is selected PPP.</p>
Remote IP	<p>This parameter identifies the IP address for the WAN port on a remote router when the WAN protocol is selected PPP.</p>

6.3.4 FrRelay Setup

Local IP	This parameter identifies the IP address for local WAN port when the WAN protocol is selected Frame Relay.
IP Netmask	WAN port IP netmask when the WAN protocol is selected Frame Relay.
Remote IP	This parameter identifies the IP address for the WAN port on a remote router when the WAN protocol is selected Frame Relay.
LMI type	Select Local Management Interface type to match the public network, or the setting at the far-end in a private network.
DLCI number	This Parameter identifier the Data Link Connection Identifier address for the connection.

6.3.5 AUX Setup

AUX Port	Enable or Disable the AUX port.
Local IP	This parameter identifies the IP address for local WAN port when the WAN protocol is selected Frame Relay.
IP Netmask	WAN port IP netmask when the WAN protocol is selected Frame Relay.
Remote IP	This parameter identifies the IP address for the WAN port on a remote router when the WAN protocol is selected Frame Relay.
AUX Port Speed	Select data speed & format

6.3.6 Routing Table

Default Gateway	If the Router Module receives a packet for an "unknown" destination (i.e. a packet with an IP address is not listed in the routing table), it forwards that packet to the Default Gateway if one has been defined.
------------------------	--

6.3.7 Device Control

Warm Start	Press the “ ENTER” key to restart the device.
Restore Default	Press the “ ENTER” key to reset the parameters to the factory defaults.

6.3.8 Monitor

LAN Rx Packets	The total number of input packets received from the LAN interface.
LAN Tx Packets	The total number of packets sent to the LAN interface.
LAN Rx Errors	The total number of input packets received from the LAN interface with specific errors (CRC error, frame error, missed packet, unknown or unsupported protocol, etc).
WAN Rx Packets	The total number of input packets received from the WAN interface.
WAN Tx Packets	The total number of packets sent to the WAN interface.
WAN Rx Errors	The total number of input packets received from the WAN interface with specific errors (CRC error, frame error, missed packet, unknown or unsupported protocol, etc).
AUX Rx Packets	The total number of input packets received from the AUX interface.
AUX Tx Packets	The total number of packets sent to the AUX interface.
AUX Rx Errors	The total number of input packets received from the AUX interface with specific errors (CRC error, frame error, missed packet, unknown or unsupported protocol, etc).

6.4 How to Operate and Setup Internet Applications

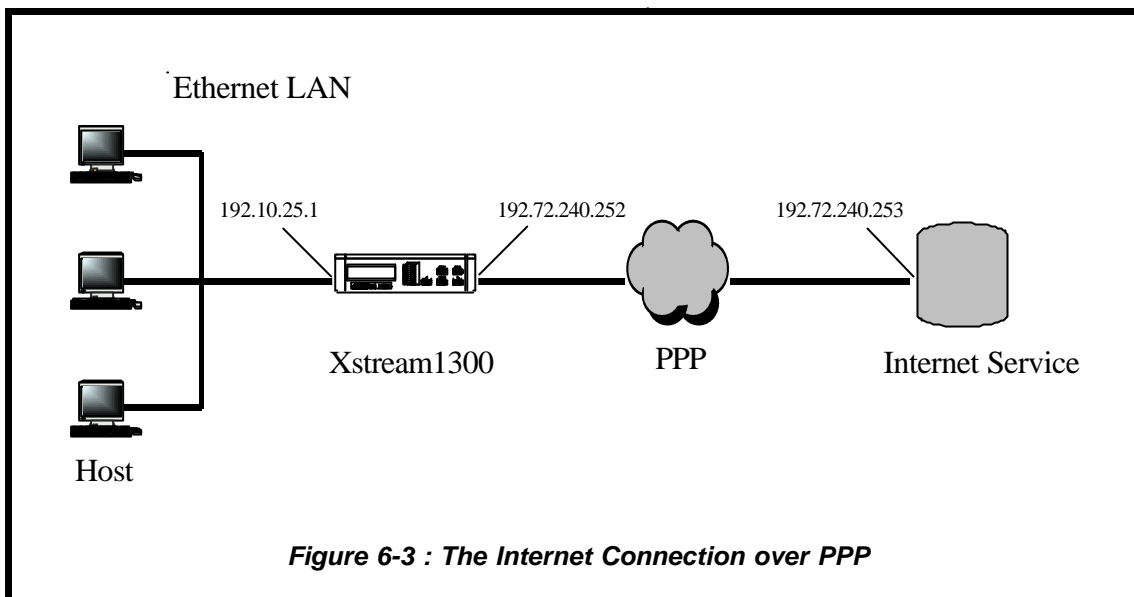

Example of Setting up the Procedures via front panel

Step 1:	Under LAN Setup menu: <i>IP Address = 192.10.25.1</i>
Step 2:	Under LAN Setup menu: <i>IP NetMask = 255.255.255.0</i>
Step 3:	Under WAN Setup menu: <i>WAN Protocol = PPP</i>
Step 4:	Under PPP Setup menu: <i>Local Address = 192.72.240.252</i>
Step 5:	Under PPP Setup menu: <i>IP NetMask = 255.255.255.252</i>
Step 6:	Under PPP Setup menu : <i>WAN Port Speed = Sync-External</i>
Step 7:	Under Routing Table menu: <i>Default Gateway = 192.72.240.253</i>
Step 8:	In an IP network, each host is configured with <i>its own IP Address and</i> <i>a Gateway IP address = 192.10.25.1</i>

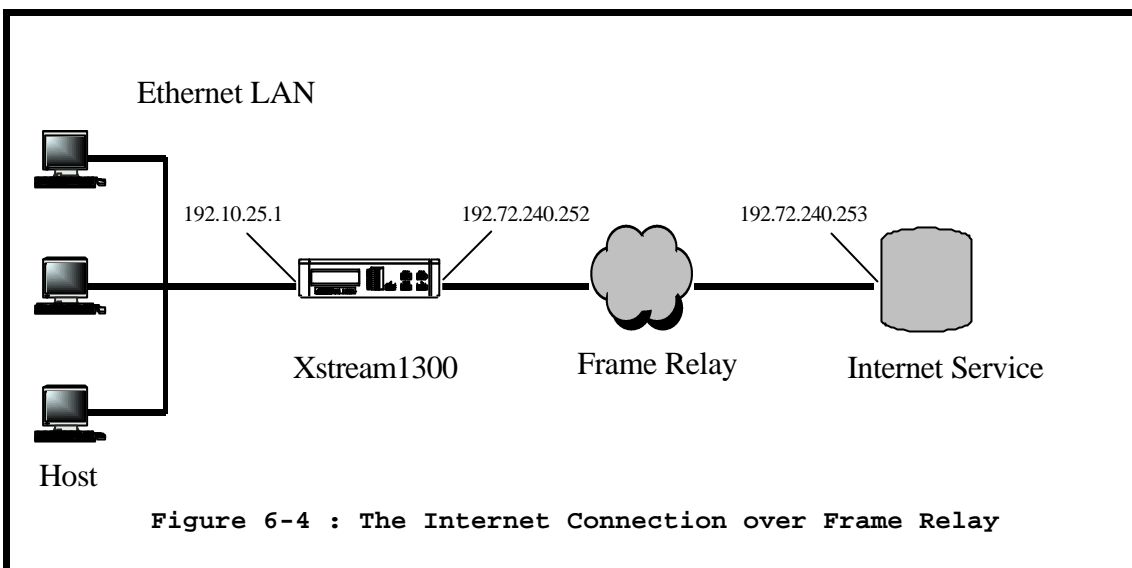

Example of Setting up the Procedures via front panel

Step 1:	Under LAN Setup menu: <i>IP Address = 192.10.25.1</i>
Step 2:	Under LAN Setup menu: <i>IP NetMask = 255.255.255.0</i>
Step 3:	Under WAN Setup menu: <i>WAN Protocol = Frame Relay</i>
Step 4:	Under FrRelay Setup menu: <i>Local Address = 192.72.240.252</i>
Step 5:	Under FrRelay Setup menu: <i>IP NetMask = 255.255.255.252</i>
Step 6:	Under FrRelay Setup menu : <i>LMI type = ANSI T1.617</i>
Step 7:	Under FrRelay Setup menu : <i>DLCI number = 150</i>
Step 8:	Under Routing Table menu: <i>Default Gateway = 192.72.240.253</i>
Step 9:	In an IP network, each host is configured with <i>its own IP Address and</i> <i>a Gateway IP address = 192.10.25.1</i>

6.5 How to Operate and Setup Intranet Applications

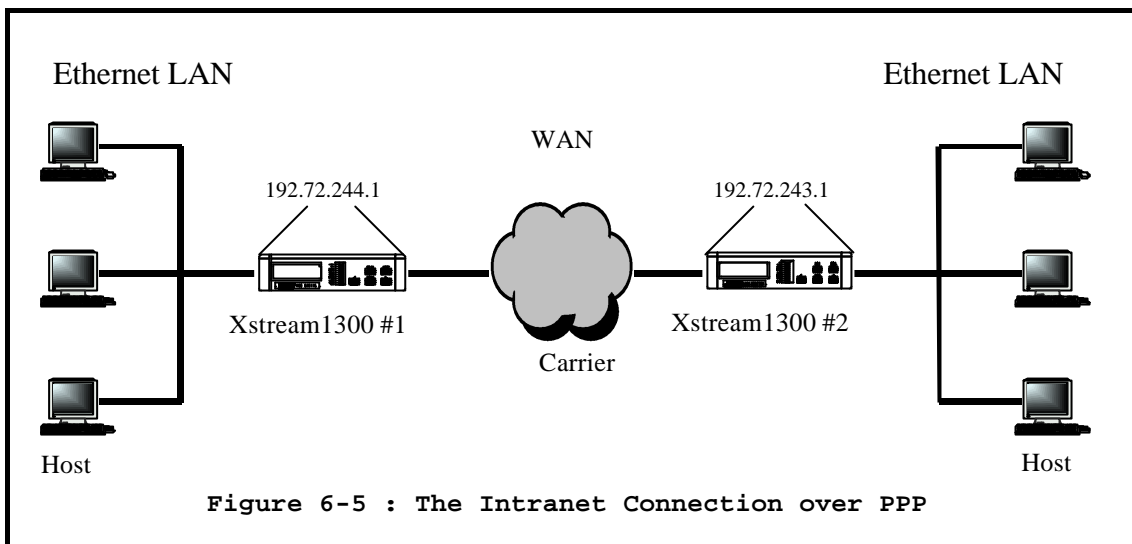

Example of Setting up the Procedures via front panel

1. XSTREAM 1300 #1 Setup

Step 1:	Under LAN Setup menu: <i>IP Address = 192.72.244.1</i>
Step 2:	Under LAN Setup menu: <i>IP NetMask = 255.255.255.0</i>
Step 3:	Under WAN Setup menu: <i>WAN Protocol = PPP</i>
Step 4:	Under PPP Setup menu: <i>Local Address = 192.72.244.1</i>
Step 5:	Under PPP Setup menu: <i>IP NetMask = 255.255.255.255</i>
Step 6:	Under PPP Setup menu : <i>WAN Port Speed = Sync-External</i>
Step 7:	Under Routing Table menu: <i>Default Gateway = 192.72.243.1</i>
Step 8:	In an IP network, each host is configured with <i>its own IP Address and</i> <i>a Gateway IP address = 192.72.244.1</i>

2. XSTREAM 1300 #2 Setup

Step 1:	Under LAN Setup menu: <i>IP Address = 192.72.243.1</i>
Step 2:	Under LAN Setup menu: <i>IP NetMask = 255.255.255.0</i>
Step 3:	Under WAN Setup menu: <i>WAN Protocol = PPP</i>
Step 4:	Under PPP Setup menu: <i>Local Address = 192.72.243.1</i>
Step 5:	Under PPP Setup menu: <i>IP NetMask = 255.255.255.255</i>
Step 6:	Under PPP Setup menu : <i>WAN Port Speed = Sync-External</i>
Step 7:	Under Routing Table menu: <i>Default Gateway = 192.72.244.1</i>
Step 8:	In an IP network, each host is configured with <i>Its own IP Address and</i> <i>a Gateway IP address = 192.72.243.1</i>

APPENDIX

Overview

Appendix-A	DTE Module Setting
Appendix-B	Order Information
Appendix-C	PINS ASSIGNMENT
C-1	V.35 Interface
C-2	RS-530 Interface
C-3	V.36/RS-449 Interface
C-4	X.21 Interface
C-5	DB-9 Interface
C-6	RJ-45 Interface
Appendix-D	Loopback
D-1	Local Loop back
D-2	Digital Loop back
Appendix-E	Factory Profiles
Appendix-F	Software Upgrade
F-1	Overview
F-2	Craft Port Download
F-3	Procedures
F-4	FLASH Download

Appendix-A DTE Module Setting

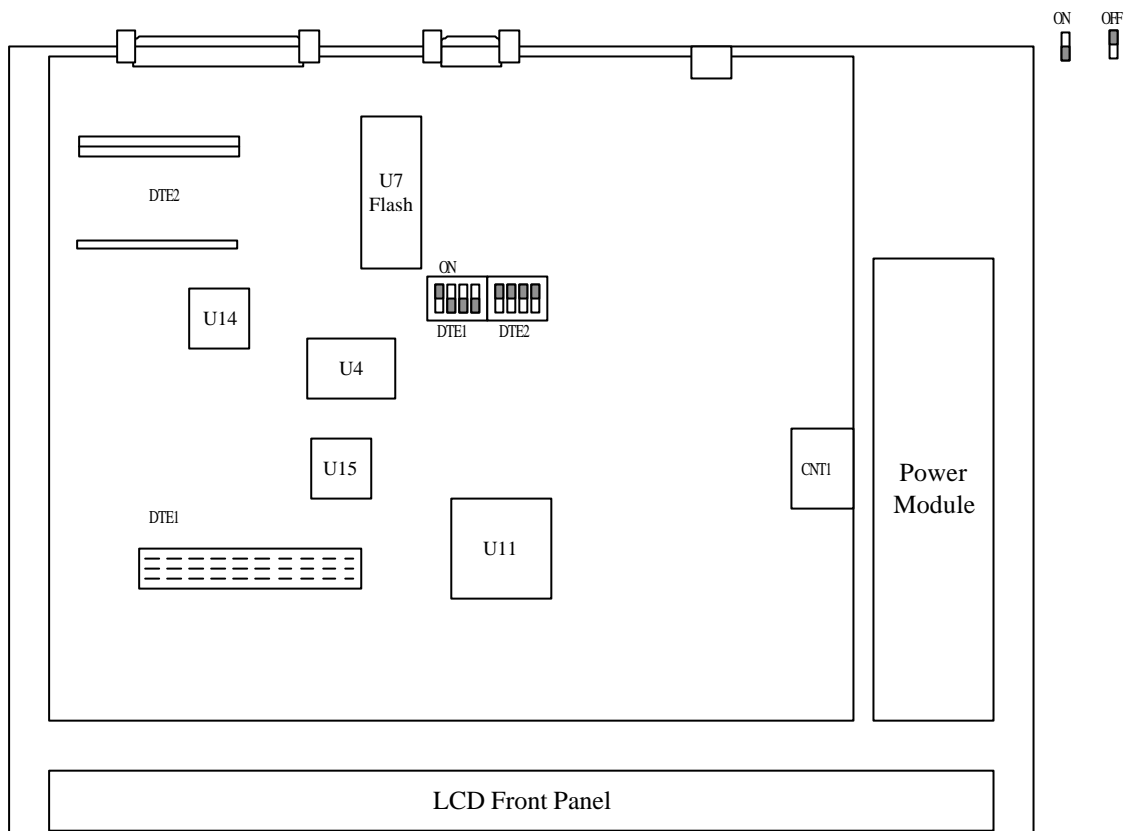

Switch	Module	Model Name	DIP 1	DIP 2	DIP 3	DIP 4
DTE 1	G.703 Module	G703B-3L	ON	ON	ON	ON
		G703U-3L	ON	ON	ON	ON
	Router Module	<i>Router-L</i>	OFF	ON	ON	ON
	Reserve					
	No Equipped		OFF	OFF	OFF	OFF
DTE 2	Reserved		ON	ON	ON	ON
			OFF	ON	ON	ON
	G.703 Module	<i>Preliminary</i>	ON	OFF	ON	ON
	V.35	V35-1F	OFF	OFF	ON	ON
	RS-530	R530-1F	ON	ON	OFF	ON
	V.36	V36-1F	ON	ON	OFF	ON
	X.21	X21-1F	ON	ON	OFF	ON
	Reserved					
	No Equipped		OFF	OFF	OFF	OFF

Appendix-B Order Information

Model Name	Part No	Description
1300/*	000075-0001	MSDSL; Up to 2M; Standalone Basic Unit; without DTE I/F; Up to two DTE I/F are supported;
1300D/*	000075-0012	MSDSL; Up to 2M; Standalone Basic Unit; without DTE I/F; Up to two DTE I/F are supported; DC power
DTE-1 I/F		
/G703B-3L	000075-0003	Full & Fractional E1, G.703 Balance
/G703U-3L	000075-0004	Full & Fractional E1, G.703 Unbalance
/ROUTER-L	000077-0001	Router Module with RJ-45 I/F
DTE-2 I/F		
/V35-1F	000075-0005	V.35 I/F; Nx64 KBPS(N=1..32); with FIFO; Female; with adaptor cable
/R530-1F	000075-0010	RS-530 I/F; Nx64 KBPS(N=1..32); with FIFO; Female
/V36-1F	000075-0020	V.36 I/F; Nx64 KBPS(N=1..32); with FIFO; Female; with adaptor cable
/X21-1F	000075-0011	X.21 I/F; Nx64 KBPS(N=1..32); with FIFO; Female; with adaptor cable

Model Name	Part No	Description
1300T/*	000075-0013	MSDSL; Up to 2M; Standalone Basic Unit; without DTE I/F module; Up to two DTE I/F are supported; Outdoor
1300DT/*		MSDSL; Up to 2M; Standalone Basic Unit; without DTE I/F module; Up to two DTE I/F are supported; DC power; Outdoor
/G703B-3LT	000075-0014	Full & Fractional E1, G.703 Balance; Outdoor
/G703U-3LT	000075-0015	Full & Fractional E1, G.703 Unbalance; Outdoor

Model Name	Part No	Description
1310/*	000075-0017	MSDSL; Up to 1M; Standalone Basic Unit; without DTE I/F;
1310D/*	000075-0018	MSDSL; Up to 1M; Standalone Basic Unit; without DTE I/F; DC power
/V35-1F	000075-0005	V.35 I/F; Nx64 KBPS(N=1..16); with FIFO; Female; with adaptor cable
/R530-1F	000075-0010	RS-530 I/F; Nx64 KBPS(N=1..16); with FIFO; Female
/V36-1F	000075-0020	V.36 I/F; Nx64 KBPS(N=1..16); with FIFO; Female; with adaptor cable
/X21-1F	000075-0011	X.21 I/F; Nx64 KBPS(N=1..16); with FIFO; Female; with adaptor cable

Model Name	Part No	Description
1320/*	000075-0006	MSDSL; Up to 2M; Line card Basic Unit; Dual-port; without DTE I/F;
/V35-2	000075-0007	Dual V.35 I/F; Nx64 KBPS(N=1..32); with FIFO; Female; with adaptor cable
/R530-2	000075-0009	Dual RS-530 I/F; Nx64 KBPS(N=1..32); with FIFO; Female
/V36-2	000075-0019	Dual V.36 I/F; Nx64 KBPS(N=1..32); with FIFO; Female; with adaptor cable
/X21-2	000075-0008	Dual X.21 I/F; Nx64 KBPS(N=1..32); with FIFO; Female; with adaptor cable
/G703-2	Preliminary	Dual G.703 Balance & Unbalance I/F; with adaptor cable

Model Name	Part No	Description
1330/*	000075-0006	MSDSL; Up to 2M; Line card Basic Unit; Dual-port; without DTE I/F;
/V35-2	000075-0007	Dual V.35 I/F; Nx64 KBPS(N=1..16); with FIFO; Female; with adaptor cable
/R530-2	000075-0009	Dual RS-530 I/F; Nx64 KBPS(N=1..16); with FIFO; Female
/V36-2	000075-0019	Dual V.36 I/F; Nx64 KBPS(N=1..16); with FIFO; Female; with adaptor cable
/X21-2	000075-0008	Dual X.21 I/F; Nx64 KBPS(N=1..16); with FIFO; Female; with adaptor cable

Model Name	Part No	Description
TRS-32/@/%/^	000053-0004	Shelf for IDSL/MDSL/HDSDL/MSDSL series; 19" Rack Mounted chassis with 50 pin centronic connector with Cooling Fan
(@)Controller Module		
/NMC-32	000055-0002	Shelf Controller with LCD and Key Pads
/CSR	000078-0002	Shelf Controller with CS function; with LCD and Key Pads
(%)Power Module		
/PW-132A	000057-0001	132W, 90~260VAC, AC Power Module
/PW-132D	000057-0002	132W, -48VDC, DC power module
/PW-132AR	000057-0001x2	132W, 90~260VAC, AC Power Module with redundant power module
/PW-132DR	000057-0002x2	132W, -48VDC, DC power module with redundant power module
/PW-180A	000082-0001	180W, 90~260VAC, AC Power Module
/PW-180D	000082-0002	180W, -48VDC, DC power module
/PW-180AR	000082-0001x2	180W, 90~260VAC, AC Power Module with redundant power module
/PW-180DR	000082-0002x2	180W, -48VDC, DC power module with redundant power module
(^)Panel Module (optional)		
/TB-32	000053-0002	Optional real panel: Daughter Board for dial line & 2wire connection
/CA50	000053-0003	Optional 50 pin cable (3.5m) for 50pin centronica connector (4 PCS)

Appendix-C PINS ASSIGNMENT

C-1 V.35 Interface

Table C-1 : V.35 Cable pin definition

DB25 Male	Signal	V.35 Female	Source
1	Frame Ground	A	Common
7	Signal Ground	B	Common
4	Request to Send	C	DTE
5	Clear to Send	D	DCE
6	Data Set Ready	E	DCE
8	Data Carrier Detect	F	DCE
20	Data Terminal Ready	H	DTE
2	Transmit Data (A)	P	DTE
3	Receive Data (A)	R	DCE
14	Transmit Data (B)	S	DTE
16	Receive Data (B)	T	DCE
24	Terminal Timing (A)	U	DTE
17	Receive Timing (A)	V	DCE
11	Terminal Timing (B)	W	DTE
9	Receive Timing (B)	X	DCE
15	Terminal Timing (A)	Y	DCE
12	Terminal Timing (B)	AA	DCE

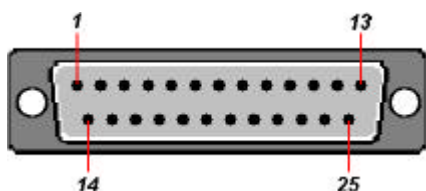

Figure C-1 : DB-25M Interface

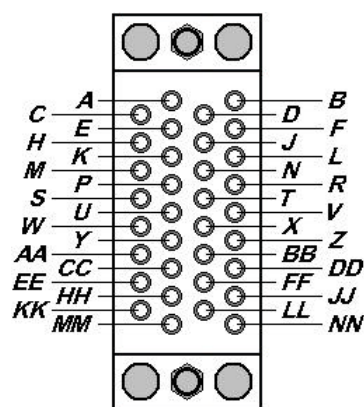

Figure C-2 : V.35 Interface

C-2 RS-530 Interface

Table C-2 : RS-530 Connector pin definition

DB25 Male	Signal	Source
1	Frame Ground	Common
2	Transmit Data (A)	DTE
3	Receive Data (A)	DCE
4	Request to Send (A)	DTE
5	Clear to Send (A)	DCE
6	DCE Ready (A)	DCE
7	Signal Ground	Common
8	Receive line Signal Detector (A)	DCE
9	Receive Signal Element Timing (B)	DCE
10	Receive line Signal Detector (B)	DCE
11	EXT. Transmit Signal Element Timing (B)	DTE
12	Transmit Signal Element Timing (B)	DCE
13	Clear to Send (B)	DCE
14	Transmit Data (B)	DTE
15	Transmit Signal Element Timing (A)	DCE
16	Receive Data (B)	DCE
17	Receive Signal Element Timing (A)	DCE
19	Request to Send (B)	DTE
20	DTE Ready (A)	DTE
22	DCE Ready (B)	DCE
23	DTE Ready (B)	DTE
24	EXT. Transmit Signal Element Timing (A)	DTE

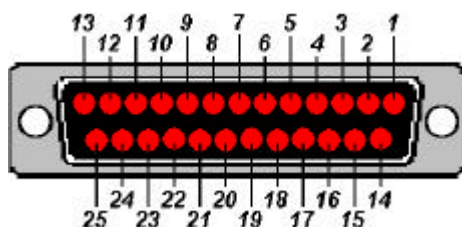

Figure C-3 : RS-530 Interface

C-3 V.36/RS-449 Interface

Table C-3 : V.36/RS-449 Cable pin definition

DB25 Male	Signal	V.36/RS-449 Female	Source
1	Shield	1	Common
2	Send Data (A)	4	DTE
15	Send Timing (A)	5	DCE
3	Receive Data (A)	6	DCE
4	Request to Send (A)	7	DTE
17	Receive Timing (A)	8	DCE
5	Clear to Send (A)	9	DCE
6	Data Mode (A)	11	DCE
20	Terminal ready (A)	12	DTE
8	Receive Ready (A)	13	DCE
24	Terminal Timing (A)	17	DTE
7	Signal Ground	19,20,37	Common
14	Send Data (B)	22	DTE
12	Send Timing (B)	23	DCE
16	Receive Data (B)	24	DCE
19	Request to Send (B)	25	DTE
9	Receive Timing (B)	26	DCE
13	Clear to Send (B)	27	DCE
22	Data Mode (B)	29	DCE
23	Terminal Ready (B)	30	DTE
10	Receive Ready (B)	31	DCE
11	Terminal Timing (B)	35	DTE

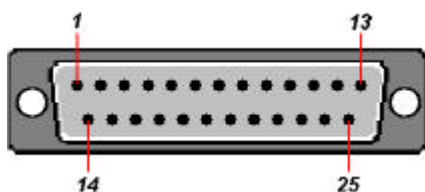

Figure C-4 : DB-25M Interface

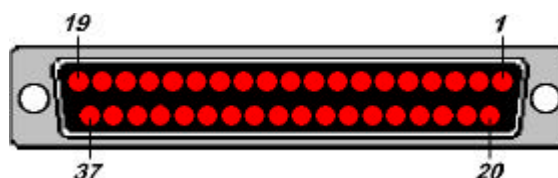

Figure C-5 : DB-37F Interface

C-4 X.21 Interface

Table C-4 : X.21 Cable pin definition

DB25 Male	Signal	X.21 Female
1	Shield Ground	1
2	Signal Ground	2
4	TXD(a)	3
3	CTRL(a)	4
8	RXD(a)	5
17	Indication	6
24	RXC(a)	7
7	Signal Ground	8
14	TXD(b)	9
19	CTRL(b)	10
16	RXD(b)	11
10	Indication	12
9	RXC(b)	13
11	EXC(b)	14
G		G

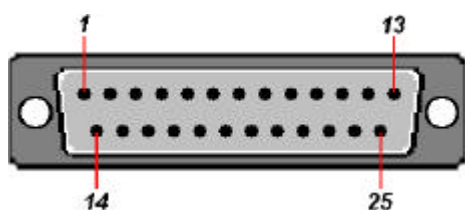

Figure C-6 : DB-25M Interface

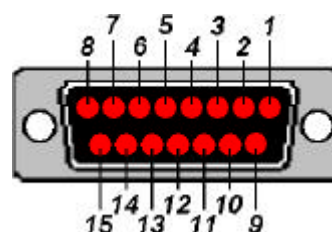

Figure C-7 : DB-37F Interface

C-5 DB-9 Interface

Table C-5 : DB9 Connector pin definition

DB9 Female	Signal	Source
2	TXD	DCE
3	RXD	DTE
5	Signal Ground	
7	CTS	DTE
8	RTS	DCE

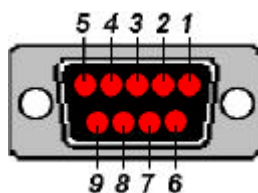

Figure C-8 : RJ-45 Interface

C-6 RJ-45 Interface

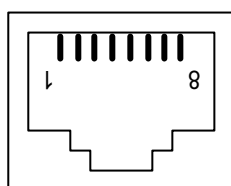

Figure C-9 : RJ-45 Interface

Table C-6 : DSL RJ-45 Connector pin definition

RJ-45	Signal
4	Tip
5	Ring

Table C-7 : LAN RJ-45 Connector pin definition

RJ-45	10BaseT Signal
1	TxD Twist Pair +
2	TxD Twist Pair -
3	RxD Twist Pair +
6	RxD Twist Pair -

Table C-8 : AUX port, RJ-45 Connector pin definition

RJ-45	AUX port description
1	TxC (Transmit Clock)
2	RTS (Request to Send)
3	TxD (Transmit Data)
4	GND (Signal Ground)
5	RxD (Receive Data)
6	DCD (Data Carrier Detected)
7	CTS (Clear to Send)
8	RxC (Receive Clock)

Appendix-D Loopback

D-1 Local Loop back

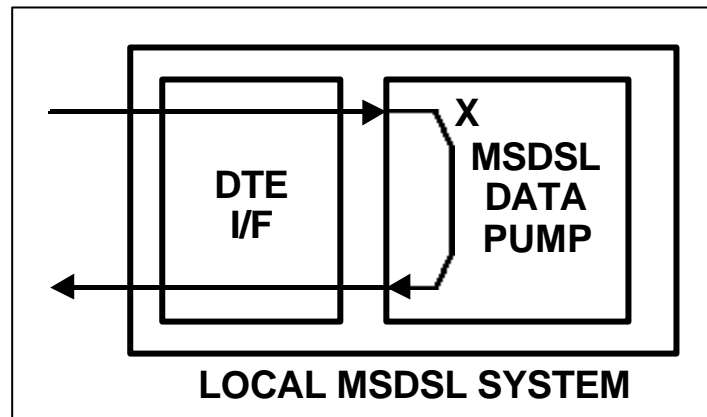

Figure D-1 : Local loop back

D-2 Digital Loop back

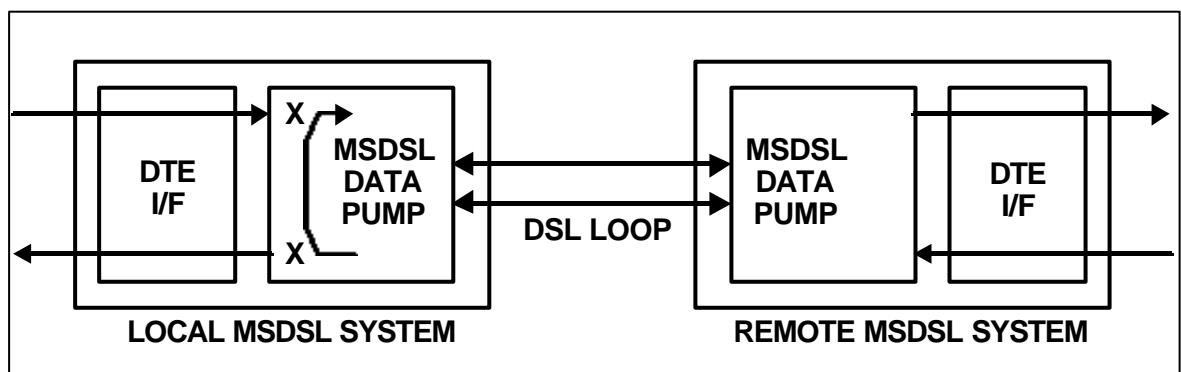

Figure D-2 : Digital loop back

Appendix-E Factory Profiles

Table E-1 : Profile Setting List 1 (RS-530/V.35)

MODEM CONFIG	0-CO-2048-INT	1-CP-2048-RCV	2-CO-2048-DTE
MODE	CO	CPE	CO
TX PWR ATTENU	-3dB	-3dB	-3dB
WERCUR	ON	OFF	ON
RISING EDGE	NORMAL	NORMAL	NORMAL
DISCONNECT	AUTOMATIC	AUTOMATIC	AUTOMATIC
TERMINATION	HI-Z	HI-Z	HI-Z

DTE CONFIG	0-CO-2048-INT	1-CP-2048-RCV	2-CO-2048-DTE
SPEED	2048 Kbps	2048 Kbps	2048 Kbps
TX CLOCK	INTERNAL CLOCK	RECEIVER CLOCK	DTE CLOCK
RATE ADAPTION	FOLLOW SET UP	FOLLOW SET UP	FOLLOW SET UP
DTE PORT	DTE 2	DTE 2	DTE 2
RTS SIGNAL	NORMAL	NORMAL	NORMAL
CTS SIGNAL	NORMAL	NORMAL	NORMAL
DCD SIGNAL	NORMAL	NORMAL	NORMAL
DTE2 RxD	Follow RxC	Follow RxC	Follow RxC
FRAME FORMAT	UNFRAMED	UNFRAMED	UNFRAMED
LCD BACKLIGHT	ON 3MIN.	ON 3MIN.	ON 3MIN.
KEY TONES	ON	ON	ON
CRAFT SPEED	19200 BPS	19200 BPS	19200 BPS

	0-CO-2048-INT	1-CP-2048-RCV	2-CO-2048-DTE
TEST CONFIG	CLOSE ALL	CLOSE ALL	CLOSE ALL

Table E-2 : Profile Setting List 2 (G.703 Full E1)

MODEM CONFIG	3 CO-E1-UF-DTE	4 CP-E1-UF-RCV	5 CO-E1-FR-DTE	6 CP-E1-FR-RCV
MODE	CO	CPE	CO	CPE
TX PWR ATTENU	-3dB	-3dB	-3dB	-3dB
WERCUR	ON	OFF	ON	OFF
RISING EDGE	NORMAL	NORMAL	NORMAL	NORMAL
DISCONNECT	AUTOMATIC	AUTOMATIC	AUTOMATIC	AUTOMATIC
TERMINATION	HI-Z	HI-Z	HI-Z	HI-Z

DTE CONFIG	3 CO-E1-UF-DTE	4 CP-E1-UF-RCV	5 CO-E1-FR-DTE	6 CP-E1-FR-RCV
SPEED	2048 KBPS	2048 KBPS	2048 KBPS	2048 KBPS
TX CLOCK	DTE CLOCK	RECEIVER CLOCK	DTE CLOCK	RECEIVER CLOCK
RATE ADAPTION	FOLLOW SET UP	FOLLOW SET UP	FOLLOW SET UP	FOLLOW SET UP
DTE PORT	DTE 1	DTE 1	DTE 1	DTE 1
RTS SIGNAL	NORMAL	NORMAL	NORMAL	NORMAL
CTS SIGNAL	NORMAL	NORMAL	NORMAL	NORMAL
DCD SIGNAL	NORMAL	NORMAL	NORMAL	NORMAL
FRAME FORMAT	UNFRAMED	UNFRAMED	FRAMED+ CRC4	FRAMED+ CRC4
LCD BACKLIGHT	ON 3MIN	ON 3MIN.	ON 3MIN.	ON 3MIN.
KEY TONES	ON	ON	ON	ON
CRAFT SPEED	19200 BPS	19200 BPS	19200 BPS	19200 BPS

	3 CO-E1-UF-DTE	4 CP-E1-UF-RCV	5 CO-E1-FR-DTE	6 CP-E1-FR-RCV
TEST CONFIG	CLOSE ALL	CLOSE ALL	CLOSE ALL	CLOSE ALL

Appendix-F Software Upgrade

F-1 Overview

The XSTREAM 1300 uses a FLASH memory as the system ROM, and it provides the software upgrade function. There are 2 steps to execute the software upgrade function :

- ✓ *Download the software via the craft port from the PCs or terminal program to the XSTREAM 1300.*
- ✓ *FLASH download and system reset.*

F-2 Craft Port Download

The Craft Port could assist the system software upgrade function for a standalone termination unit like Tainet' s XSTREAM 1300. The PCs or terminals with COM port could be connected to the XSTREAM 1300 via the craft port. The procedures for this connection are :

F-3 Procedures

1. Make sure that PCs or Terminals of the COM port setting are set to
 - ✓ *115200 baud rate*
 - ✓ *8-bit characters*
 - ✓ *No parity*
 - ✓ *1 stop bit*
 - ✓ *Hardware flow control*
 - ✓ *ANSI terminal type*
 - ✓ *1K-XMODEM file transfer protocol*
2. Plug the 9-pin of the terminal cable to both ends (the XSTREAM 1300' s Craft Port and PC' s COM port).
3. If the PC' s COM port is not the 9-pin of the terminal cable but 25-pin one, the user can change the adapter through correct pin assignments.

4. Turn off the XSTREAM 1300.
5. Presses the UP, RIGHT, LEFT three keys at same time.
6. Turn on the XSTREAM 1300.
7. Release the UP, RIGHT, LEFT three keys when LCD screen presents “Upgrade Key Hit!” and then the LCD will displays “FLASH ERASING!”.
8. The XSTREAM 1300 FLASH memory dumps will display on the PC’s or Terminal s Monitor if the connection is successful.
9. When “C” character is present, send the binary file (USEFLASH.BIN) of new XSTREAM 1300 software use 1K-XMODEM file transfer protocol. (See Figure D-1)
10. If downloads successfully the XSTREAM 1300 FLASH memory new dumps will display again.

4800:0000=	ff ff ff ff ff ff ff ff	ff ff ff ff ff ff ff ff
5000:0000=	ff ff ff ff ff ff ff ff	ff ff ff ff ff ff ff ff
5800:0000=	ff ff ff ff ff ff ff ff	ff ff ff ff ff ff ff ff
6000:0000=	ff ff ff ff ff ff ff ff	ff ff ff ff ff ff ff ff
6800:0000=	ff ff ff ff ff ff ff ff	ff ff ff ff ff ff ff ff
7000:0000=	ff ff ff ff ff ff ff ff	ff ff ff ff ff ff ff ff
7800:0000=	ff ff ff ff ff ff ff ff	ff ff ff ff ff ff ff ff
8000:0000=	54 41 49 4e 45 54 20 58	53 54 52 45 41 4d 20 4d	TAINET XSTREAM M
8800:0000=	c7 06 50 1a 80 00 5e 5d	cb a0 3c 19 b4 00 40 8b	..P...^]..<...@.
9000:0000=	26 8a 87 8a 01 b4 00 b1	07 d3 e0 03 d8 03 de 8a	&.....
9800:0000=	08 2c 08 30 08 34 08 38	08 3c 08 40 08 44 08 48	.,.0.4.8.<.@.D.H
A000:0000=	26 09 00 04 00 04 f8 c8	00 04 d8 f8 00 04 00 04	&.....
A800:0000=	99 99 99 99 99 99 99 99	99 99 99 99 99 99 99 99
B000:0000=	99 99 99 99 99 99 99 99	99 99 99 99 99 99 99 99
B800:0000=	fa fc b8 54 02 8e d0 bc	00 20 b8 40 00 8e c0 b8	...T.....@.....
C000:0000=	54 41 49 4e 45 54 20 58	53 54 52 45 41 4d 20 4d	TAINET XSTREAM M
C800:0000=	c7 06 50 1a 80 00 5e 5d	cb a0 3c 19 b4 00 40 8b	..P...^]..<...@.
D000:0000=	26 8a 87 8a 01 b4 00 b1	07 d3 e0 03 d8 03 de 8a	&.....
D800:0000=	08 2c 08 30 08 34 08 38	08 3c 08 40 08 44 08 48	.,.0.4.8.<.@.D.H
E000:0000=	26 09 00 04 00 04 f8 c8	00 04 d8 f8 00 04 00 04	&.....
E800:0000=	99 99 99 99 99 99 99 99	99 99 99 99 99 99 99 99
F000:0000=	99 99 99 99 99 99 99 99	99 99 99 99 99 99 99 99
F800:0000=	fa fc b8 54 02 8e d0 bc	00 20 b8 40 00 8e c0 b8	...T.....@.....
CCCCCCC			

Figure F-1 : The XSTREAM 1300 Memory Dumps

F-4 FLASH Download

When the XSTREAM 1300 software has downloaded completely, the system will reprogram the FLASH and after that, reset the system automatically.

Appendix-G Trouble Report

Company					
Local Representation					
Purchase Order No					
Equipment Serial No					
Software Version					
Please describe:	<table> <tr> <td>1. Testing Network Structure</td> <td>2. Configuration</td> </tr> <tr> <td>3. Testing Network Equipment</td> <td>4. Trouble Description</td> </tr> </table>	1. Testing Network Structure	2. Configuration	3. Testing Network Equipment	4. Trouble Description
1. Testing Network Structure	2. Configuration				
3. Testing Network Equipment	4. Trouble Description				
E-MAIL :					
TEL :	FAX :				
Signature :	Date : / /				

TAINET COMMUNICATION SYSTEM CORP. FAX : 886-2-2658-3232

E-MAIL : #sales@tainet.net

Glossary

A

<i>ABOUT THIS MANUAL</i>	iii
<i>ALM</i>	1-5, 2-4
<i>Applications</i>	1-7
<i>Auto Baud Rate</i>	4-8

C

<i>Campus network</i>	1-8
<i>CAP</i>	1-4
<i>Cellular network</i>	1-7
<i>Clock accuracy</i>	1-4
<i>Clock source</i>	1-4
<i>Configuration Procedure</i>	3-4
<i>Copyright</i>	ii
<i>CPE</i>	1-5, 2-4
<i>Craft port</i>	5
<i>CRAFT SPEED</i>	4-10
<i>CTS SIGNAL</i>	4-8

D

<i>DB9 Connector</i>	A-9
<i>DCD SIGNAL</i>	4-9
<i>Definition of key</i>	2-6, 4-2
<i>Diagnostic</i>	1-5
<i>DISCONNECT</i>	4-6
<i>DISPLAY STATUS</i>	5-6
<i>DOWN</i>	1-5, 4-3
<i>DSL</i>	1-5, 2-4
<i>DTE CONFIG</i>	4-4, 4-7

<i>DTE PORT</i>	4-8
<i>DTE1</i>	1-5, 2-4, 4-13
<i>DTE2</i>	1-5, 2-4, 4-13
<i>DTE2 RxD</i>	4-9

E

<i>E1 network</i>	2-8
<i>Environment</i>	1-5

F

<i>Feature</i>	1-3
<i>FRAME FORMAT</i>	4-9
<i>Front Panel</i>	2-2

H

<i>HOME</i>	2-5, 4-3
<i>Humidity</i>	1-5

I

<i>INTERFACING</i>	2-1
--------------------------	-----

K

<i>KEY TONES</i>	4-10
<i>Keyboard</i>	5-2
<i>Keypad</i>	1-5

L

<i>last mile</i>	1-2
<i>LCD</i>	1-5
<i>LCD BACKLIGHT</i>	4-10

- LCD Display*..... 2-3
LEFT..... 1-5, 2-3
LINE..... 4-12
Load Factory Profile..... 3-4
LOAD PROFILE..... A-7
LOC/REM..... 1-5
Local Loopback Test..... 3-5
Loop impedance..... 1-4
- M**
- Main Menu* 4-2
Make Connection..... 4-6
MODE..... 4-5
MODEM CONFIG..... 4-4, 4-5
Modulation..... 1-4
Module..... 1-4
MSDSL..... 1-2
- P**
- Pop-Up Boxes* 5-3
Power Consumption..... 1-5
Power Source 1-5
PROFILE..... 4-4, 4-14
PWR..... 1-5, 2-4
- R**
- RATE ADAPTION* 4-8
RCV GAIN..... 4-12
Reach..... 1-4
Rear panel..... 3-7
RIGHT..... 1-5, 4-3
RISING EDGE 4-6
RJ-45 Connector A-9, A-10
ROUTER..... 6-1
RS-530 Connector..... A-6
RTS SIGNAL..... 4-8
- S**
- S/N*..... 4-12
- Sealing Current*..... 1-5
SERVICE..... iv
Setup Procedures..... 3-3
Specification..... 1-4
SQ..... 1-5, 2-4
STATUS 4-4, 4-12
Status Indicator..... 1-5
Status Indicators 2-4
Submenu..... 4-4
SYSTEM CONFIGURATION..... A-5
System Menu, 3
- T**
- Temperature* 1-5
TERMINATION..... 4-6
TEST CONFIG 4-4, 4-11
TIME SLOT NO 4-10
TIME SLOT START..... 4-9
Top Menu 2-3
Trouble Report 4-7, A-15
TST..... 1-5, 2-4
TX CLOCK..... 4-7
TX POWER..... 4-12
TX PWR ATTENU..... 4-5
- U**
- Unpacking*..... 3-2
UP..... 1-5, 4-3
- V**
- V.35 Cable*..... A-5
- W**
- WARRANTY*..... iv
WETCUR..... 4-6
Wetting Current..... 4-6
- X**
- X.21 Cable* A-7, A-8